



# CCH™ Elite 30 High-Tech Commercial Pool Disinfection with Powerful Performance





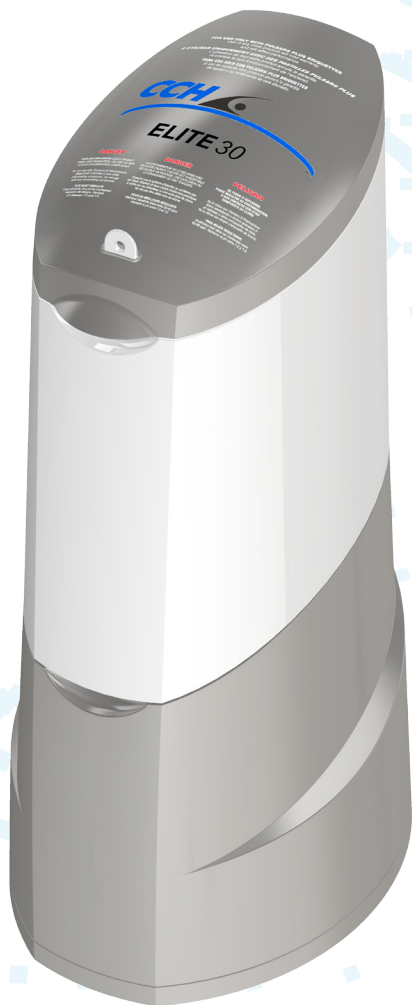

The **CCH™** Elite 30 feeder is a high capacity erosion (HCE) feeder that is compact and lightweight with a modular design.

The feeder uses **CCH™** Tablets that produces a fresh concentrated liquid chlorine solution for clean and sanitized water. This innovative feeder system is easy to maintain and service with a flexible design that allows for easy integration for small to medium size commercial pools.







Switch to the **CCH™** Elite 30 Feeder System, delivering clear and sparkling water time and time again!



## Powerful Feeder Performance

-  No booster pump required for feeder operation
-  Provides consistent chlorine delivery
-  Feeder designed to minimize maintenance requirements
-  Injection molded components hold up to the strongest elements
-  Feeder design allows for easy access to internal components
-  Features high capacity erosion technology with the benefits of a venturi

## Briquette Efficiencies

-  Won't overstabilize pool
-  More concentrated than liquid bleach
-  Dry, easy to handle formulation
-  Will not cause reduction of ORP
-  Highly concentrated to reduce shipping and handling costs
-  Longer shelf life when compared to liquid bleach



# CCH™ Elite 30

Secure lid locking feature

Briquette grid

Removable for easy maintenance

High capacity erosion nozzle

Emergency shut-off valve to prevent spills

Durable discharge valve

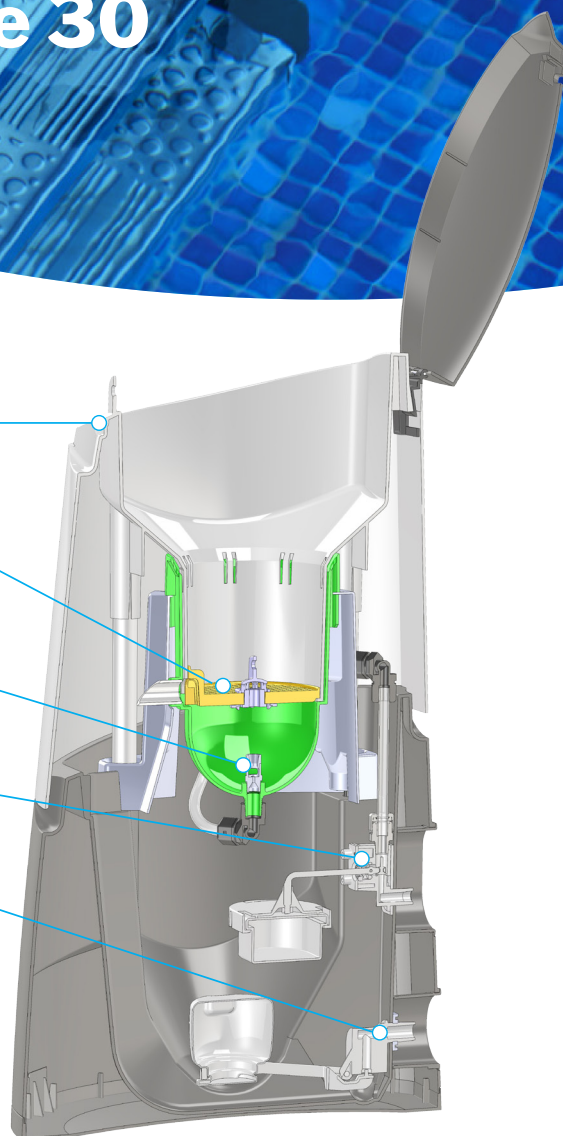

### Recommended Pool Size (For guidance only)

Outdoor Non-Stabilized	Up to 90,000 gal.
Outdoor Stabilized	Up to 150,000 gal.
Indoor	Up to 200,000 gal.
Spas	Up to 15,000 gal.

### Feeder Specifications

Width	15.5"	393.7 mm
Depth	19.5"	495.3 mm
Height	34.0"	863.6 mm
Water Inlet Size	1/2" MNPT	12 mm MNPT
Solution Outlet Size	1/2" MNPT	12 mm MNPT
Operating Weight	52 lbs	23.6 kg
Shipping Weight	20 lbs	9.1 kg
Dry Chemical Capacity	30 lbs	13.6 kg
Electrical		None
Operating Temperature	40°- 120° F	4.4°- 49° C

### Chemical Specifications

Active Ingredient	Calcium Hypochlorite	
Available Chlorine	68%	
Scale Inhibitor	0.4-1.0%	
Weight	7-10g	
Dimensions	1 1/4" x 3/4" x 1/2"	33mm x 19mm x 13mm
Chemical Form	Pillow shaped briquette	
Color	White	
Container	50lb pail	22.6kg pail



cchpoolcare.com  
1-800-478-5727