

*inver*CHLOR

Salt System



INSTALLATION MANUAL

WELCOME

This is the instruction manual for your Madimack InverCHLOR Salt System. This guide will help you understand the operation and maintenance of your salt system, ensuring clean and clear pool water for your enjoyment.

| CONTENTS

1 SAFETY WARNINGS	4
2 SPECIFICATIONS	5
3 INVERCHLOR CONTROLLER CONNECTIONS	6
4 Acid Feeder (Optional)	7
5 CONTROLLER OVERVIEW	8
5.1 Controller Commands & Functions	9
5.2 Controller Shortcuts	9
6 INSTALLATION	10
6.1 Electrical Connections	10
6.2 Pool Water Preparation	
6.3 Adding salt before operation	10
6.4 Water Balance	10
6.5 Installing the InverCHLOR	11
6.5.1 Mounting the InverCHLOR	11
6.5.2 Cell housing installation	11
6.5.3 Plumbing connections	12
6.6 Installing the Acid Feeder	12
6.6.1 Diluted acid and Acid Feeder Location	12
6.6.2 Mounting the Acid Feeder	13
6.6.3 Connecting the Acid Feeder	13
6.6.4 Priming the Acid Feeder	13
7 FIRST TIME START-UP	13
8 OPERATION (USING THE INVERCHLOR)	14
8.1 Setting the 24-hour clock	14
8.2 Pool Volume Setting	14
8.3 Setting the Mode (AUTO/ MANUAL)	14
8.4 Acid Dosing (with the added Acid Feeder)	14
8.4.1 Understanding the Acid Feeder	14
8.4.2 Setting the Acid Dosing Volume	15
8.4.3 Average aily dose of diluted acid by pool volume	15
8.5 Setting the AUTO Mode Timers	15
8.6 Boost Mode	15
8.7 Input	16
8.8 Connecting the Heater Command Cable	16
8.9 WiFi and App Connection	16
9 MAINTENANCE	17
9.1 Restore Factory Settings	17
9.2 Power-down Memory	17
9.3 Adding Salt or Minerals	17
9.4 Measuring Salinity reading	17
9.5 Backwashing and Draining Water	17
9.6 Cell Maintenance	17
9.6.1 Cleaning the Cell (only if required)	17
9.6.2 Removing the Cell Plates from the Cell Housing	18
9.7 Low Chlorine Protection	18
9.8 Acid Feeder Maintenance	18
9.9 Error Codes	19
9.10 Display Indicators	19
10 Maintenance Mode - Authorised Technicians Only	20
11 Warranty	21

1 | SAFETY WARNINGS



PLEASE READ THE MANUAL CAREFULLY BEFORE INSTALLATION & OPERATION AND RETAIN IT FOR FUTURE REFERENCE.



Adhering to the directions for use in this manual is extremely important for health and safety. Failure to strictly adhere to the requirements in this manual may result in personal injury, property damage and affect your ability to make a claim under the manufacturer's warranty provided with your product. Products must be used, installed and operated in accordance with this manual. You may not be able to claim on the manufacturer's warranty in the event that your product fault is due to failure to adhere this manual.

IMPORTANT SAFETY INSTRUCTIONS READ AND FOLLOW ALL INSTRUCTIONS

This manual contains important information about the installation, operation, and safe use of this product. Failure to follow these instructions may result in personal injury, property damage, or death.

WARNING

- To reduce the risk of injury, do not permit children to use this product unless they are always supervised.
- To reduce the risk of electric shock, replace any damaged cords immediately.
- The unit must be connected only to a supply circuit that is protected by a ground-fault circuit interrupter (GFCI). The GFCI should be provided by the installer and should be tested on a routine basis. To test the GFCI, push the test button. The GFCI should interrupt power. Push the reset button. Power should be restored. If the GFCI fails to operate in this manner, the GFCI is defective. If the GFCI interrupts power to the pump without the test button being pushed, a ground current is flowing, indicating the possibility of an electric shock. Do not use this product. Disconnect the InverCHLOR and have the problem corrected by a qualified service representative before reconnecting it.

CAUTION

- This product is for use with permanently installed pools. Do not use it with storable pools. A permanently installed pool is constructed in or on the ground or in a building such that it cannot be readily disassembled for storage. A storable pool is constructed so that it is capable of being readily disassembled for storage and reassembled to its original integrity.
- Never open the inside of the enclosure.
- When servicing the product, use only identical replacement parts.
- The water temperature of the pool should not exceed 40°C (104°F). High temperatures may be hazardous to your health.
- This Pump is for Use with Permanently-Installed Pools Only -Do Not Use with Storable Pools.
- To reduce the risk of electric shock, install at least 5 feet (1.5m) from the inside walls of a pool. Do not use an extension cord.
- To ensure continued protection against shock hazard, use only identical replacement parts when servicing.

2 | SPECIFICATIONS

Model Name	inverCHLOR MC150	inverCHLOR MC250	inverCHLOR MC400
Model Code	MC150NA	MC250NA	MC400NA
Pool Volume Up to (Gal)	15,000 Gallons	25,000 Gallons	40,000 Gallons
Pool Volume Up to (Litres)	57,000 Litres	95,000 Litres	150,000 Litres
Chlorine 24h (3000ppm)	0.85lb - 384g	1.38lb - 624g	1.91lb - 864g
Chlorine 24h (1200ppm)	0.38lb - 173g	0.74lb - 280g	0.86lb - 389g
Cell Amps (3000ppm)	7	11	14
Cell Amps (1200ppm)	4.6	7	8.4
Cell Voltage (v)	12	12	12
Power Consumption (w)	104	151	197
Power Supply (vac)	100-240v (50/60hz)		
IP Rating	IP65		
Salt Range (ppm)	1200-6000ppm		
Recommended Salt Level (ppm)	3000ppm		
Operating Temp (°F)	23 - 108°F		
Operating Temp (°C)	-5 - 42°C		
Optimum Water Temp (°F)	50 - 104°F		
Optimum Water Temp (°C)	5 - 40°C		
Controller Dimensions (in)	9.65 x 7.87 x 3.15"		
Controller Dimensions (mm)	245 x 200 x 80mm		
Cell Dimensions (in)	12.87 x 4.61 x 5.97"		
Cell Dimensions (mm)	327 x 117 x 150mm		
Water Connection (in)	1.5 / 2"		
Water Connection (mm)	40 / 50mm		

**All measurements calculated at 77°F / 25°C water temperature

** 10,000 Operating hours on the cell.

3 | INVERCHLOR CONTROLLER CONNECTIONS

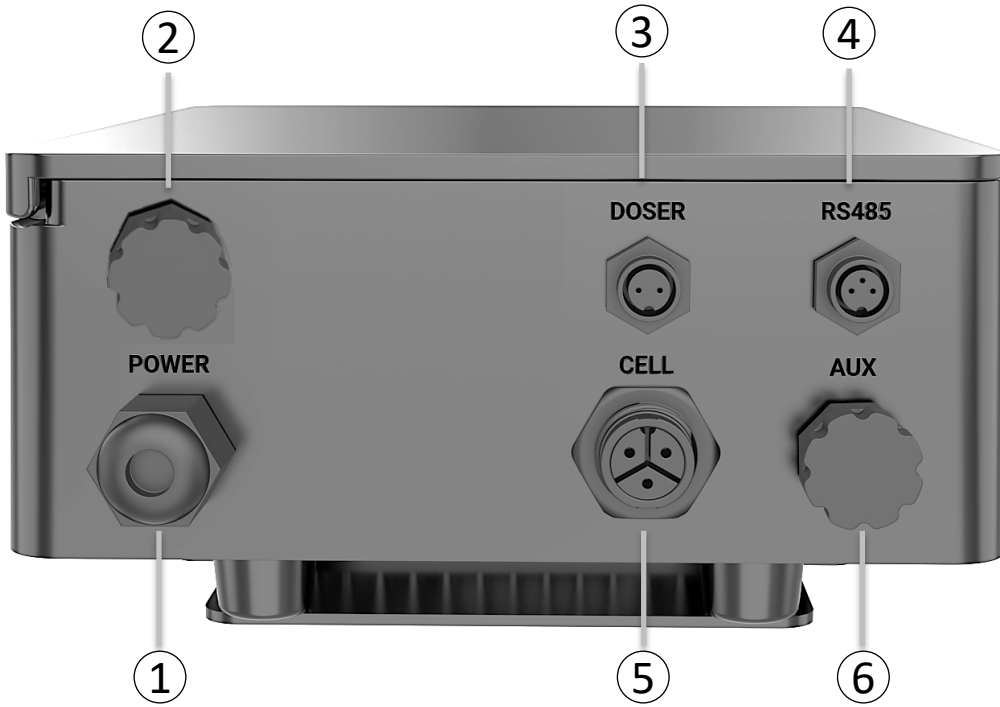

NO.	PORT NAME	DESCRIPTION
1	Power Input	AC Power Connector (100~240V, 50/60Hz)
2	Pump Output (low voltage)	Pump output comms connection. *Use 'Digital Input 2' wires for Inverflow Plus control
3	Doser (Optional)	Connector for the optional Acid Feeder. Push in the plug end and hand tighten the locking nut.
4	RS 485	**Future provision only
5	Cell Power Output	Connect the lead from the Cell housing to the port labelled CELL. Push in the plug end and hand tighten the locking nut. Without this an E1 or E3 error will appear.
6	AUX (Heater)	If using the pump call (HEATER CMD) function, connect the communication cable from the heat pump to the supplied AUX plug, then push the plug into the port and hand tighten the locking nut.

TIP: The connection ports have keyways that only allow the cable connection in one orientation.

4 | Acid Feeder (optional)

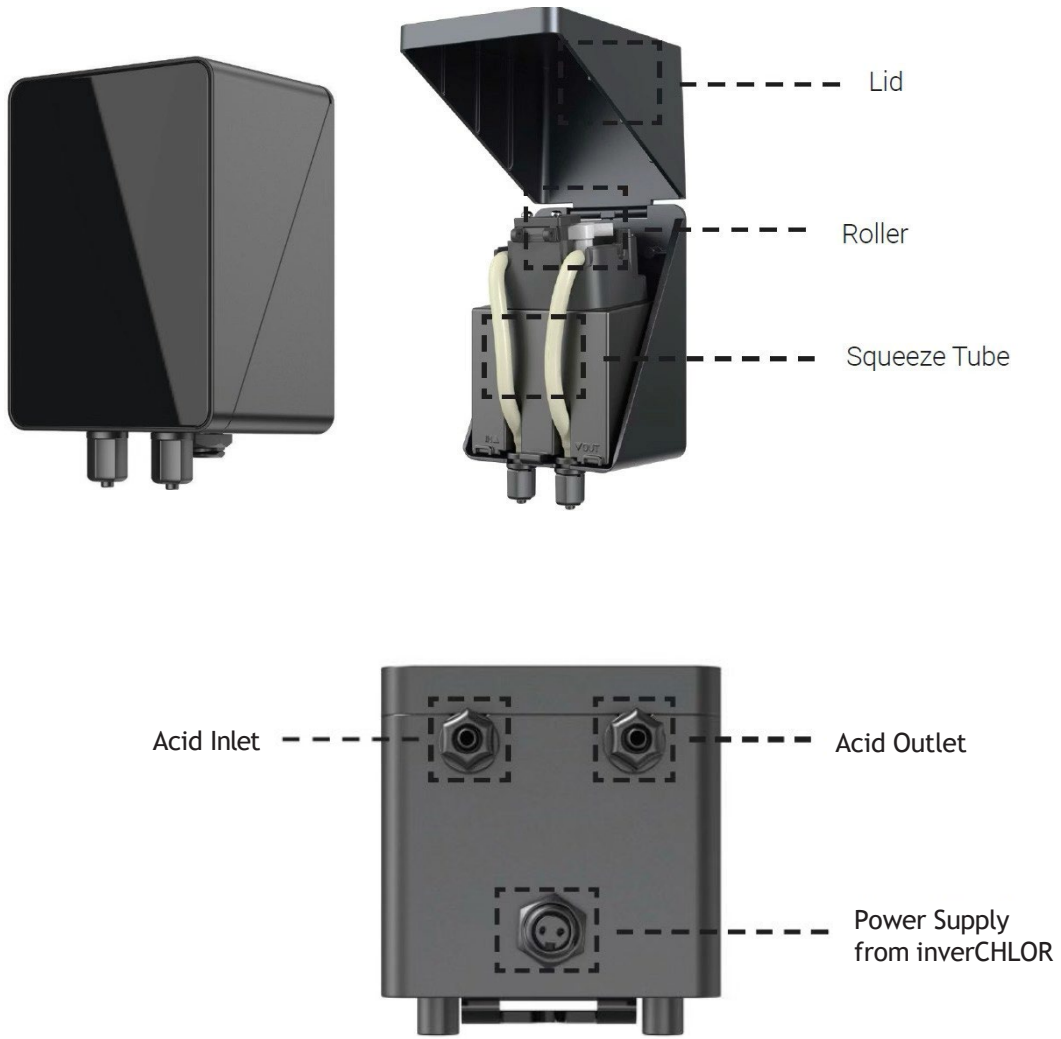



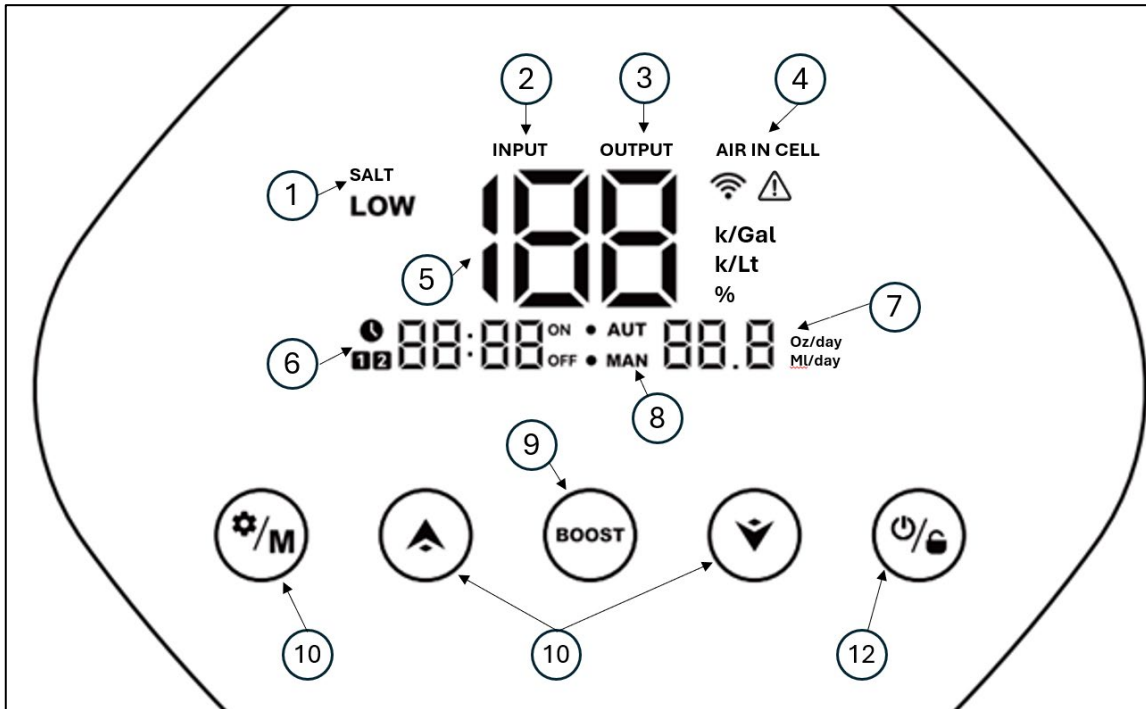

(Left to Right: Spare squeeze tube, Lubricant, Suction filter, Injection Tee, 5m Dosing tube)

5 | CONTROLLER OVERVIEW















MARKED AREA	DESCRIPTION	ICON
1	<ul style="list-style-type: none"> Pool Salt Type (Salt) Low Salt Alarm 	SALT LOW
2	Heater input - pump call activated	INPUT
3	<ul style="list-style-type: none"> Pump Output activated 	OUTPUT
4	<ul style="list-style-type: none"> Air detected in cell Wi-Fi connection status Error notification 	AIR IN CELL
5	<ul style="list-style-type: none"> Chlorine Production (%) Pool Volume (k/Gal or k/Lt) 	100 k/Gal k/Lt %
6	<ul style="list-style-type: none"> Timers Enabled Clock Display Timer Active or Inactive 	12 00:00 ON OFF
6	Chlorine Mode (Auto/Manual)	<ul style="list-style-type: none"> • AUT • MAN
7	Acid Dosing amount/ day	00.0 Oz/day Ml/day
8	Settings/ Menu/ Enter	
9	Adjust Up	
10	Boost Mode	
11	Adjust Down	
12	Power/ Lock Screen	

5.1 Controller Commands and Functions

COMMAND KEYS	FUNCTION
	<ul style="list-style-type: none"> • Lock/Unlock: Hold for 3 seconds (The auto lock function will be activated after 1 minute without any operation) • Power ON/OFF: Tap
	<ul style="list-style-type: none"> • Activate BOOST: Tap for 24 hours constant operation of cell and pump • Exit BOOST: Tap
	<ul style="list-style-type: none"> • Press: Main Menu (Mode/Dosing/Timers). • Hold for 3 seconds: Pool Settings (Clock/Volume/Salt type) • Save new setting: If a setting is flashing, hold for 3 seconds to save and return.
	<ul style="list-style-type: none"> • Adjust Up: On the home screen will adjust chlorine output up in 1 % increments. (hold to increase speed) • When limit is reached soft beep will sound
	<ul style="list-style-type: none"> • Adjust Down: On the home screen will adjust chlorine output down in 1 % increments. (hold to increase speed) • When limit is reached soft beep will sound

5.2 Controller Shortcuts

FUNCTION	SHORTCUT
Access the Start-Up Menu	In the home screen, hold  for 3 seconds
Restore Factory Settings	Enter the menu  , then hold  &  for 3 seconds
Activate WiFi Pairing	Enter the menu  , then hold  &  for 3 seconds
Save Settings & Return Home	While in any menu, hold  for 3 seconds to return to the home screen
Prime the Acid Feeder for 15 seconds*	While in standby (OFF), hold  &  for 3 seconds
Measure the Salinity	In the home screen, hold  &  for 3 seconds

* Requires the optional Acid Feeder

6 | INSTALLATION

6.1 Electrical Connections

- DO NOT OPEN THE INVERCHLOR CONTROLLER/ POWER PACK.
- The power pack must be installed a minimum of 2 feet (0.6 m) vertically off the ground. Ensure the power pack is protected from direct water exposure.
- In the US, the power pack must be installed a minimum of 1.5 m (5 ft.) from the inside wall of your swimming pool or spa.
- Ensure that power is disconnected prior to performing any wiring.
- Follow all local and NEC (CEC if applicable) codes.
- The Madimack InverCHLOR is supplied with a power cable and plug for plug and play installation.
- If the InverCHLOR power supply requires hardwiring the plug can be cut off the cable and the 3m cable used for the connection.
- The InverCHLOR is designed to operate on a large voltage input range and both frequencies of power supply 100-240v (50/60hz). No settings are required to be changed.

6.2 Pool Water Preparation

Before operating the InverCHLOR it is important to prepare the pool water. The water chemistry must be balanced, and salt or minerals added. Certain adjustments to the chemical balance of the pool can take several hours.

6.3 Adding Salt Before Operation

1. Add the salt with the pump running at least 24 hours before turning on the InverCHLOR.
2. Ensure that the salinity is within the recommended range. The ideal level is 3000ppm.
3. For accuracy, measure the salinity 6 to 8 hours after the amount has been added to the swimming pool.

IMPORTANT:

- If the water in the pool is not fresh and/or if it is liable to contain dissolved metals, use a metal remover, according to the manufacturer's instructions.
- If your water has previously been treated with a product other than chlorine (bromine, hydrogen peroxide, PHMB, etc.), neutralize this product or replace all the water in the pool.
- If using mineral salt (Magnesium chloride and / or Potassium chloride) add approx. 1.4 times the amount of normal salt. (Optimum mineral salt level 4200ppm)

6.4 Water Balance

The water must be balanced manually BEFORE the device is started.

The following table summarizes the recommended levels for the InverCHLOR. Your water should be checked regularly to maintain these concentrations to protect the equipment and minimize surface corrosion or deterioration.

CHEMISTRY	RECOMMENDED LEVELS
Salt	Salt 3000ppm (4200ppm if using minerals)
Free chlorine	Free chlorine 1.0ppm to 3.0ppm
pH	pH 7.2 to 7.6
Cyanuric acid (Stabiliser)	20-50 ppm, 0 ppm for indoor pools (Add stabiliser only if necessary. Do not exceed 50ppm)
Total alkalinity	80 to 120 ppm
Water hardness (Calcium)	200 to 300 ppm
Metals	0 ppm
Algaecide	Use of algaecide is an option. Maintain copper <0.2ppm

6.5 Installing the InverCHLOR

WARNINGS

- ⚠ Choose a suitable, well-ventilated location within one metre of the filter equipment and mount the power supply vertically onto a wall or post that is at least as wide as the InverCHLOR controller.
- ⚠ Madimack advises that the power supply should not be placed within 10 feet of the pool water.
- ⚠ Connect the InverCHLOR power supply to an appropriate weatherproof power outlet/controller.
- ⚠ Ensure the unit is kept away from acid and other chemical storage areas, as acid and chemical vapours can corrode the electronics inside the unit.
- ⚠ The unit should also be kept away from heat sources. Proper ventilation is essential for correct operation.

6.5.1 Mounting the InverCHLOR

1. Screw the mounting plate to the wall.
2. Hang the InverCHLOR by aligning the lugs on the back of the InverCHLOR with the lugs on the wall bracket and sliding down.

6.5.2 Installing the Cell Housing

WARNINGS

- ⚠ Ensure the cell housing is the highest plumbing point to allow correct operation of the air sensor protection
- ⚠ The Cell housing must be installed as the last piece of equipment before the water returns to the pool.

IMPORTANT: The solvent cement or primer can cause damage if allowed to contact the threads or the orings. This will prevent a seal causing a leak.

1. The cell housing should be installed in a horizontal position to ensure adequate water flow over the cell plates and the air sensor. Failing to install this way, may cause products faults and void warranty.



NOTE: If the cell housing is to be installed in a vertical orientation, the power supply connection cap and the air sensor must be the highest point of the installation AND the water must enter the bottom union.

Warning: Not following this guideline is a safety risk and will void warranty.

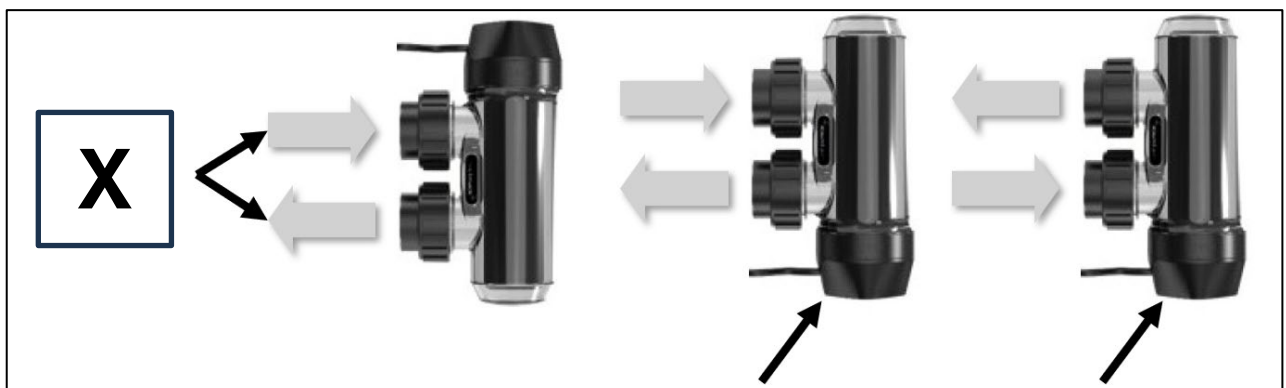

6.5.3 Plumbing Connections

1. The InverCHLOR is supplied with 1.5" and 2" unions to connect to the PVC plumbing.
2. Ensure a suitable solvent cement is used to glue the unions to the pipework.
3. To avoid turbulent flow causing false readings with the air sensor, ensure a minimum of 200mm pipework for the inlet and outlet of the cell housing.
4. Ensure the union nuts are on the pipe before gluing the union tails.
5. Once the solvent cement has set, place the cell housing onto the pipework and hand tighten the union nuts with the orings in place.



IMPORTANT: The solvent cement or primer can cause damage if allowed to contact the threads or the orings. This will prevent a seal causing a leak.

6.6 Installing the Acid Feeder

- The Madimack Acid Feeder is an automated algorithmic acid dosing pump designed to help maintain the pH levels in a chemically balanced pool.
- The Acid Feeder will dose controlled amounts of diluted acid only during the operating timers of the InverCHLOR. The amount dosed is based on the setting on the InverCHLOR made by the installer or operator.

NOTE: It is the responsibility of the owner to continually monitor the operation and maintenance of this product to ensure safe operation and prevent damage to surrounding equipment or negative effects to the pool chemistry.

WARNINGS: ⚠

- If the following instructions are not followed, there can be damage to persons & products. This may also void warranties.
- Suitable Personal Protective Equipment (PPE) must be worn during the process. Consult warnings on chemical containers where necessary.
- The pool acid **MUST** be diluted before use. Always add the small amount of chemical to a large amount of water.

6.6.1 Diluted acid and Acid Feeder Location

The acid drum used for the Acid Feeder pump may release corrosive fumes that can damage pool equipment and electrical or metal items.

The diluted acid connected to the Acid Feeder must be stored in a well-ventilated area and more than 3ft away horizontally from any pool equipment.

1. The Acid Feeder should be a minimum of 6.5ft away from the acid drum but no higher than 15ft above it.
2. The diluted acid connected to the Acid Feeder must be stored in a well-ventilated area and more than 3ft away horizontally from any pool equipment.
3. A breather tube should be used out of the diluted acid container.

Note: The Acid Feeder is supplied with 16ft of tubing to be used for both suction and dosing lines.

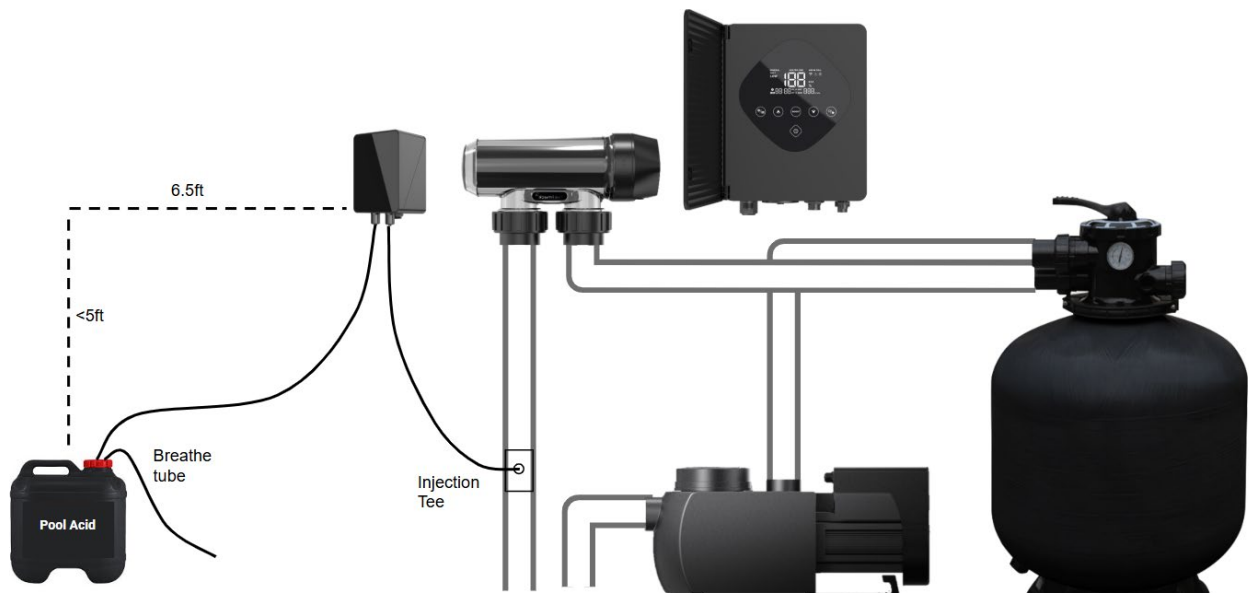

6.6.2 Mounting the Acid Feeder

1. The Acid Feeder comes with a mounting bracket attached.
2. Fix one of the self-tapping screws into the desired location and hang the dosing pump using its wall bracket on the back

6.6.3 Connecting the Acid Feeder

1. The supplied tubing will be used for the suction and dosing lines.
2. Ensure the minimum distances are met using the diagram above.
3. The tubing should enter the chemical drum through an airtight hole created with a drill bit the same size as the dosing tube.
4. Install the suction filter at the end of the suction line
5. Connect the other end to the inlet side (left) of the dosing pump securing hand tight with the locking nut.
6. Connect the outlet side (right) of the Acid Feeder to the injection Tee and hand tighten the locking nuts.
7. Connect the power supply cable to the port on the InverCHLOR marked 'DOSER'.

Note: The injection Tee contains a one-way valve to prevent pool water flowing backwards into the chemical drum.

6.6.4 Priming the Acid Feeder

⚠ Pool (muriatic) acid must be diluted prior to use at a minimum dilution ratio of 2:1 (water to acid).

⚠ Only add acid into water – DO NOT add water into acid.

- Pool acid is typically 32% strength Hydrochloric Acid.
- Dilution down to 10% is to reduce the corrosiveness and extend the working life of the products.
- Non foaming acid may already come at a strength close to 10%. This does not require dilution.

To dilute, add 2 gallons of water to a container then add 1 gallon of acid. This should be done in a container suitable for use with pool acid.

Do not use Sulphuric Acid.

Test the connections by priming the Acid Feeder pump.

1. Ensure the chemical drum contains diluted acid 2:1.
2. Turn the InverCHLOR off with its power button.
3. Hold & for 3 seconds to start the Acid Feeder for 15 seconds. You may need to run this again depending on the length of the tubing to check connections for leaks.

TIP: Refer to the following operation section in this manual to understand setting the dosing amounts

7 | FIRST TIME START-UP

These steps will automatically load when you first start the InverCHLOR or if you perform a factory reset.

Tip: The instructions for these steps are found in this manual under the 'operation' section.

1. Set the 24hr clock
2. Set the timers for AUTO mode
3. Set the pool volume
4. Select the salt type (salt/ mineral)

8 OPERATION (USING THE INVERCHLOR)

8.1 Setting the 24-hour clock

1. Hold for 3 seconds
2. When the local time is blinking, set hours of the local time by tapping and .
3. Tap to set the minutes in the same way.
4. Hold for 3 secs to save the new time or press to continue to set the pool volume.

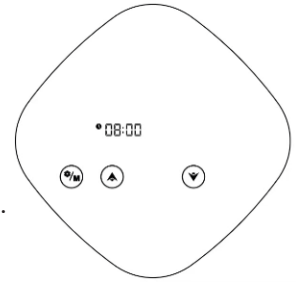

8.2 Pool Volume Setting

1. Hold for 3 seconds
 2. Press two times to skip past the clock settings.
 3. The pool size value is now blinking, it can be adjusted from 5 to 150 m³, in increments of 5m³, by tapping or .
- Tip:** Hold the button can accelerate the selection speed.
4. Hold for 3 secs to save the new volume or press to continue to set the salt type.



8.3 Setting the Mode (AUTO/ MANUAL)

1. The chlorinator can be configured to 2 different Chlorine production modes. These are selected by pressing the button then tapping or .
- Auto Mode:** Timer control pump operation and or output (1 or 2 Timers)
- Manual Mode:** Manual control of pump operation and chlorine output.

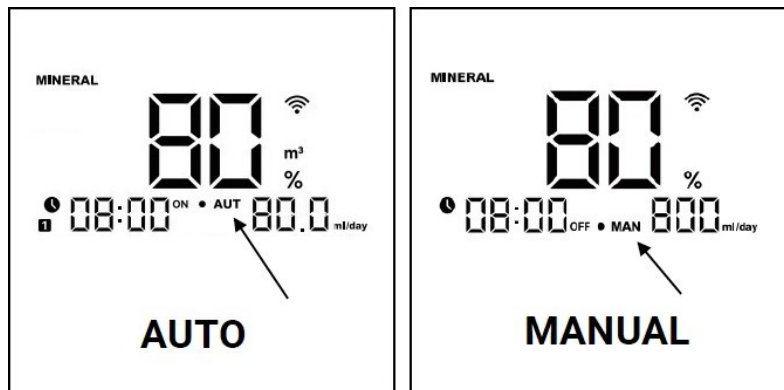

8.4 Acid Dosing (Optional Acid Feeder required)

8.4.1 Understanding the Acid Feeder

Maintaining a constant pH has many benefits including reducing the amount of chlorine required, saving on other chemicals and protecting the pool surface.

- If you have added the Acid Feeder, you can set the daily dosage amount to assist in maintaining a consistent pH level.
- Once the amount is set, the InverCHLOR will use an algorithm to determine the times to dose and the amount to dose at each interval.

TIP: The dosing amount can be set up to 999ml/day. It can be set in 10ml increments up to 999mls.

8.4.2 Setting the Acid Dosing Volume

IMPORTANT: This is a guide only. The required amount is affected by many variables.

TIP: During the initial startup period, have the water tested frequently (i.e. daily) and make small adjustments every 2-3 days, until the pH level remains balanced.

1. To access the acid dosing volume setting. Press \odot to show AUTO/ MAN.
2. Press \odot again to show the ml/day dosing amount flashing.
3. The amount can be adjusted from 0ml to 999ml in increments of 10ml, by tapping or holding \triangle & ∇ .
4. Hold the \odot button for 3 secs to confirm.

8.4.3 Average Daily dose of diluted acid by pool volume:

Pool Volume Gallons	Daily Dose Oz 32% after mixing 1:2 with water	Pool Volume Gallons	Daily Dose Oz 32% after mixing 1:2 with water
2500	5 oz/day	15000	30 oz/day
5000	10 oz/day	17500	35 oz/day
7500	15 oz/day	20000	40 oz/day
10000	20 oz/day	22500	45 oz/day
12500	25 oz/day	25000	50 oz/day

Note: These figures are an estimate based on summer conditions to offset the pH increase from chlorine generation

8.5 Setting the AUTO Mode Timers

1. To access the timer settings. Press \odot to show AUTO/ MANUAL.
2. Ensure AUTO is selected and press \odot again to show the dosing amount flashing.
3. Press \odot again to show the ON and **1**.
4. Set the starting hour of the Timer 1 using \triangle and ∇ .
5. Save the time by tapping \odot , then set and save the minutes in the same way.
6. Press \odot to save the Timer 1 ON time.
7. When ON disappears and OFF lights up, set the Timer 1 end time adjusting the hours and minutes in the same way.
8. Press \odot to save the Timer 1 OFF time
9. When **2** lights up, repeat steps 4-8 for Timer 2.

NOTE:

Do not overlap the timers. If timers are overlapped, it will not save the timer. One timer can be used by not setting the second timer.

8.6 Boost Mode

Boost mode is useful when a countdown timer with 100% chlorine output is required. This can be after weather events, a high bather load or low chlorine levels detected requiring a boost.

1. To turn on boost mode, tap BOOST with the screen unlocked.
2. 100% output will display with a countdown timer starting at 23:59.
3. The InverCHLOR will run at 100% chlorine output for the duration of the timer also providing power to the filter pump.
4. To cancel boost mode at any time, tap BOOST.

NOTE:

- If alarms occur during the timer, the BOOST mode will cancel.
- If the InverCHLOR loses power, the 24-hour timer will restart when power is restored.
- When the boost mode stops, the system will revert to the settings prior to the boost.



8.7 Input (pump call)

The InverCHLOR can act as a heat demand controller for the connected heater and filter pump.

- This allows the heat pump timers to start the water supply pump without producing chlorine, allowing the heater to operate outside of the salt system timers, avoiding over chlorinating.
- When the heater timers are activate, the system sends a pump call signal, which is indicated by **INPUT** on the display screen, activating the pump **OUTPUT** without the InverCHLOR cell.
 - The heater (AUX) and pump (Pump Output) must be connected to the salt chlorinator.

8.8 Connecting the Heater Input Cable

<p>1) You will receive this AUX cable with the Madimack InverCHLOR.</p> 	<p>2) Connect the cable to the AUX input on the bottom of the InverCHLOR.</p> 	<p>3) The other end of the cable will connect to the P1 and P2 terminals socket on the heater labelled 'Pump Control'.</p> 
---	---	--

- 4) Set the timers on the heater to operate the filter pump without the InverCHLOR producing chlorine.
- 5) When the heater timers are active you will see "INPUT" on the display screen.







Diagram of Status Relationship:

This table represents whether the pool pump will be powered on, depending on the heater and InverCHLOR Status.

InverCHLOR Status	Heat Pump Status	Water Pump Status
OFF	OFF	OFF
OFF	ON	ON
ON	OFF	ON
ON	ON	ON





8.9 WiFi and App Connection

To connect the Madimack InverCHLOR to the Invergo App please follow these steps.

1. Download the Invergo App on your smart device.
2. Unlock the InverCHLOR and tap  to enter the menu.
3. Hold  and  for 3 seconds to enter Wi-Fi pairing.
4.  will illuminate in a counterclockwise pattern:
5. While the InverCHLOR is in pairing mode, open the Invergo App and press the + symbol to add a new device.
6. The App will scan the nearby area for products in pairing mode.
7. An image of the InverCHLOR screen will appear with an ADD button.
8. Press **ADD** then select the Wi-Fi network and enter your network Password.
 - a. **NOTE** - The InverGo App will only work on the 2.4ghz bandwidth. Ensure your Wi-Fi network is not using the 5ghz bandwidth for making this connection.
9. Select the product to add it into the App.
10. The InverCHLOR will then attempt the connection.
11. If  appears, the Wi-Fi is connected.
12. If  appears, the Wi-Fi failed to connect, and it will revert back to main screen.

9 | MAINTENANCE

9.1 Restore Factory Settings

- Tap  to enter the menu screen.
- Hold  and  for 3 seconds. A beep will sound.
-  will light up then the InverCHLOR will reset, and the first-time startup process will begin.

9.2 Power-down Memory:

If there is an abnormal power failure during operation, when the power is restored, the controller automatically restarts and continues to run according to the state before power failure.

9.3 Adding Salt

- ⚠ **The InverCHLOR must remain OFF during this operation and until the additive is completely dissolved. Operating the InverCHLOR with non-dissolved salt could irreversibly damage the cell and the power supply, and lead to a void of the warranty.**
- ⚠ **For any new pool builds please wait for four weeks before adding salt into any recently cement coated pool and discuss this process with your pool builder.**

1. To achieve the required salinity, add 1x 40-pound bag of salt for every 3500gallons.
2. The ideal salinity range is 3000-5000ppm.
3. Make sure the InverCHLOR is disconnected from power during the salt adding process.
4. Turn on the filtration system for at least 24 hours, allowing the salt to dissolve completely.
5. The salt dissolving process must be accelerated using a pool broom.
6. The salt concentration may reduce over time due to rain or other periodic freshwater contributions (topping up, backwashing, etc.).

IMPORTANT: Whenever the salt concentration needs to be corrected, pour salt as close as possible to the return jets. Never pour salt in the skimmers or near any suction inlets.

9.4 Measuring Salinity reading

With the InverCHLOR on, enter the 'Monitoring' screen by holding  and  for 3 seconds.

- Upon initial access to the interface, an automatic salinity measurement is conducted
- Salinity measurement: 20 minutes per time

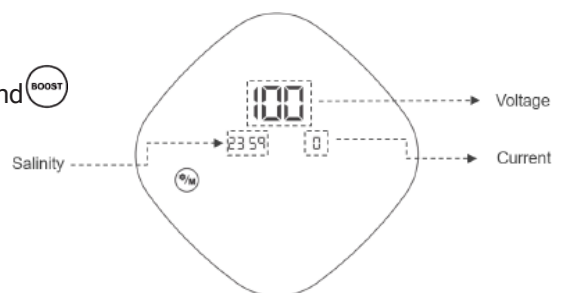

9.5 Backwashing and Draining Water

As the InverCHLOR is protected by an air sensor it may produce an E3 (low flow) error when backwashing or draining water longer than 3 minutes. In the case you require further pump operation you can either clear the E3 error with the POWER button or plug the pump into a separate power outlet and operate it manually.

9.6 Cell Maintenance

9.6.1 Cleaning the Cell (if required)

The smart polarity inversion system is designed to prevent the electrode plates from corrosion and scaling (default setting is 4 hours). However, periodic cleaning may be required when the water hardness is too high.

The cleaning process is listed as follows:

1. Turn off the InverCHLOR and the filter pump, close the isolation valves, and ensure power is disconnected at the isolating switch.
2. Undo the two unions holding the cell housing to the plumbing.
3. Place the cell upside down and fill it with a salt cell cleaning solution so that the electrode plates are immersed.
 - a. Do not allow the cell cap assembly to be immersed.
4. Follow the instructions carefully on the salt cell cleaner product label.

5. Leave the cleaning solution to dissolve the scale deposit for about 15 minutes.
6. Dispose of the cleaning solution at an approved waste recycling site, never pour into the rainwater drainage system or into the sewers.
7. Rinse the electrode using clean water and put it back on the cell fixture collar (there is an alignment mark).
8. Retighten the union nuts, open the isolation valves and restart the InverCHLOR and filter pump.
9. If you do not use a commercially available cleaning solution, you can manufacture it yourself by carefully mixing 1 part of hydrochloric (pool) acid with 10 parts of water (Warning: always pour the acid into the water and not the opposite. Wear suitable protective equipment!).
10. Make sure that the setting of the polarity inversion cycles is adapted to the pool water hardness.

9.6.2. Removing the cell plates from the cell housing

1. Remove the end cap from the cell housing
2. Unscrew the locking ring on the end of the cell housing.
3. Carefully slide out the cell plates avoiding scratching or rubbing.

9.7 Low Chlorine Protection

- Overheat protection will be activated when the temperature inside the main controller is higher or equal to 70°C.
- Overheat protection will be lifted when the temperature drops below 68°C.

Current Chlorine Output	Low-Chlorine (Initial time)	Subsequent Less-Chlorine
0-20%	---	---
21-40%	5%	Determined at every 2-minute: 1) Decreasing by 3% for every 1°C. 2) Minimum down to 20%.
41-80%	15%	Determined at every 2-minute: 1) Decreasing by 9% for every 1°C. 2) Minimum down to 20%.
81-100%	20%	Determined at every 2-minute: 1) Decreasing by 12% for every 1°C. 2) Minimum down to 20%.

9.8 Acid Feeder Maintenance

- ⚠ Pool acid fumes are corrosive. It must be handled safely and according to the manufacturer's instructions.
- ⚠ Not diluting the acid will result in premature deterioration of the dosing and squeeze tube potentially leading to leaks and voiding warranty.
- ⚠ The use of undiluted acid is indicated by discoloration of the tubing and/or the tubing losing flexibility. Following the maintenance schedule will prolong the life of the product and ensure correct operation.

PERIOD	MAINTENANCE
WEEKLY	<ul style="list-style-type: none"> • Check the level in the acid drum • Check for leaks
6 MONTHS	Lubricate the squeeze tube with a silicone-based lubricant i.e. Oring lubricant
YEARLY	Replace the squeeze tube

9.9 Error Codes

Pool acid fumes are corrosive. It must be handled safely and according to the manufacturer's instructions. Not diluting the acid will result in premature deterioration of the dosing and squeeze tube potentially leading to leaks and voiding warranty.





The use of undiluted acid is indicated by discoloration of the tubing and/or the tubing losing flexibility. Following the maintenance schedule will prolong the life of the product and ensure correct operation.





Error Code	Descripton	Logic	Action
E1	Abnormal Electrolysis	a. Electrolytic output power greater than 10% b. Voltage less than 0.8V or current less than 0.3A	A. E1 occurred B. Stop electrolysis: Restart electrolysis after 30 minutes. If abnormal electrolysis is detected 3 times in a row, electrolysis function cannot be restarted again.
E3	Abnormal water level	After the air switch indicator is triggered and continues for 120s	A. E3 occurred B. Stop the Filter Pump
E4	Over Temperature (Power pack)	Temperature >75° C (Inside)	A. E4 occurred B. Stop electrolysis
81 ~ 100%	20%	Determined at every 2-minute: 1) Decreasing by 12% for every 1° C. 2) Minimum down to 20%.	Determined at every 2-minute: 1) Decreasing by 3% for every 1° C. 2) Minimum down to 20%.

9.10 Display Indicators

Description	Logic	Action
AIR IN CELL	Read the status of the air switch for 15 seconds: If the air switch is in contact with air for 6 seconds or more before 15s of the current time, it is determined that air has entered the cell.	A. Stop electrolysis  AIR IN CELL
LOW SALT	When the salinity is detected to be less than 2500ppm for 30 seconds, it is determined to be Low Salt. (salinity alarm is adjustable in maintenance mode)	LOW
INPUT	Read the on/off status of the heater for 15 seconds: If the heater starts/on for 6 seconds or more, it is determined that the heater is in ON status.	INPUT

10 | Maintenance Mode - Authorised Technicians Only

1. Press  to OFF status.
2. To enter 'Maintenance Mode' hold  and  for 3 seconds.
3. Press  for 3s to return the main Menu.

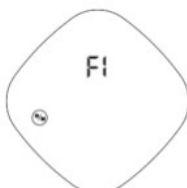
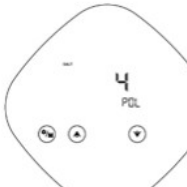
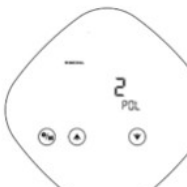
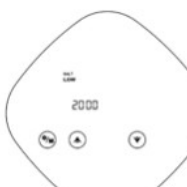
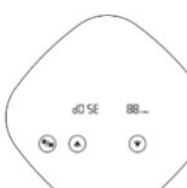
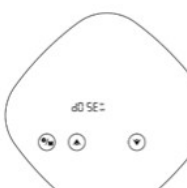
No.	Function	Photo	Remark
1	Full Screen Display		Test illumination of the screen
2	Cell Production		Test the cell output with On/Off option
3	Model Query		MC150/ 250/ 400 (Equal to 08/16/26/36)
4	Cell Life Span Status		Operating Hours of Cell plates
5	Internal Temperature display		Display the real time temperature °C of the power pack
6	Mode Display		Only F1 mode (future provision)
7	Polarity Reverse Setting (Salt)		Range: 1-10 h Default: 4 hr
8	Polarity Reverse Setting (Mineral)		Range: 1-10hr Default: 2hr
9	Low Salt Alarm Setting		Range: 1500-3000 ppm Default: 2000 ppm
10	Acid Adding Testing		eg. Set 88 ml, the pump will add 88 ml of acid at one time.
11	Dosing Pump Testing/ Priming		ON: Active Doser OFF: Non Doser

11 | Warranty

STANDARD CONDITIONS

USA and Canada ON ALL PARTS Madimack Pty Ltd distributes pool products and provides the following warranties:

STATUTORY RIGHTS

This document sets forth the comprehensive terms and conditions governing the warranty provided by Madimack ("Madimack") for specified equipment, as indicated on the accompanying card. These warranty terms are supplementary to the statutory rights conferred upon the owner.

LIMITED WARRANTY

Please visit www.madimack.com/us for all warranty terms and conditions

Madimack will, at its discretion, repair or replace any product proven to be defective during the warranty period for either materials or manufacture. Alternatively, Madimack will pay the cost of repair or replacement within 90 days of receiving the defective product, subject to unforeseen delays. This warranty is applicable for domestic installations only, is personal to the original purchaser, and does not transfer to any subsequent purchasers.

EXCLUSIONS

To the extent permitted by law, Madimack excludes all statutory or implied conditions and warranties, as well as any other liability that may arise under statute or at law, including without limitation liability for breach of contract, negligence, or any other cause of action. The following exclusions apply:

- Incorrect installation or operation of the unit resulting from failure to follow the provided instructions.
- Damage caused due to misuse or any means other than a manufacturer defect
- Repairs or servicing performed by unauthorised dealers or service stations.
- Damage caused by an unauthorised service agent repair.
- Faults in the machine's operation caused by using non-specified accessories.
- General wear and tear of consumable items.

LIMITATION OF LIABILITY

To the extent permitted by law, Madimack's liability under any condition or warranty that cannot be legally excluded in relation to the supply of goods and services is limited to one of the following options:

- Repairing the goods.
- Replacing the goods with equivalent products or services.
- Paying the cost of replacing the goods or providing equivalent products or services again. Paying the costs of repairing the goods.

PROCEDURE FOR WARRANTY CLAIMS

Making a claim

The following steps should be taken when making a warranty claim with Madimack Pty Ltd.

1. Owners experiencing issues with their system are to contact Madimack Pty Ltd service departments online portal to and provide the requested information. www.madimack.com.au
2. A service agent will review the provided information and will contact you on the provided phone number to try and solve the issue.
3. If the issue cannot be dealt with over the phone, owners will be supplied with details of service agent in their area
4. Owners will need to contact and deal with service agents directly in relation to the booking in and payments of works related to the service or repair of their Madimack product.
5. Owners can claim reimbursement for costs of works covered under the product warranty when completed by an approved Madimack Service Agent. When making a claim, owners will need to provide the following documents.
 - Proof that you are the original system owner - original invoice showing owner name and property address.
 - Copy of invoice from an approved Madimack approved service agent.
 - For a major defect a copy of the report for major defects from approved Madimack Service agent.

In the event of a warranty claim, the faulty product should be returned to the place of purchase or, to an authorised service and warranty agent repair centre.

You are responsible for arranging the removal of the defective product and the installation of the repaired or replacement product. This includes all transportation costs and any applicable insurance fees associated with transporting the products to the supplier and the replaced or repaired product from the supplier.

All returns require Madimack's written approval and must be accompanied by either:

A service support ticket authorized by Customer Service Manager or Authorised Agent, or A "Goods Return Authorisation".

madimack