



## DYN-6210-04 ELITE / DYN-6310-04 ELITE

2 & 3 Person Model Saunas



# OWNER'S MANUAL

**CARBON MODEL SAUNAS**

**FOR INDOOR USE ONLY**

**DYN-6210-04 - 120VAC 15AMP Dedicated Circuit Required**

**DYN-6310-04 - 120VAC 20AMP Dedicated Circuit Required**

Carefully and thoroughly read this Owner's Manual before using/operating the sauna. We recommend keeping this Owner's Manual for regular review and future reference. Parts and accessories may vary and are subject to change.

## TABLE OF CONTENTS

Packing List	2
Visual Assembly Diagrams	6
Schematics	8
Schematic Layout	10
Dimensional Diagram	12
Screw Identification	14
Highlights	15
Assembly Instructions	18
Operating the Sauna	24
Maintenance	28
Tips for Using Your Sauna	28
Safety Instructions	29
Safeguards for Your Sauna	31
Troubleshooting Guide	31
Warranty	38
Warranty Registration	40

**WARNING: Visually inspect all heaters before assembly to make sure they are not damaged. Any excessive vibrations during transport could cause damage to the heating elements. DO NOT START the sauna if damage is detected! Contact your dealer or manufacturer for troubleshooting and replacement parts.**

### Packing List (main panels)

1pc Front Panel	1pc Rear Panel	1pc Right Side Panel
1pc Left Side Panel	1pc Roof Panel	1pc Roof Cover
1pc Bench	1pc Bench Heat Emitter Panel	1pc Floor Panel

**NOTE: Your model sauna has been completely assembled and tested prior to packaging. The rear wall panel is intentional warped as part of the overall design. Two adults will be needed to assemble the sauna room.**

**CAUTION: Exit Sauna Immediately If You Feel Dizzy, Sleepy, Or Any Discomfort.**

The information provided in this Owner's Manual is for informational purposes only and may not be construed as medical advice or instruction. The information is not recommended for any particular treatment and in all cases, it is recommended that you consult with your medical physician before using. This product does not constitute or imply any medical endorsement. The pictures and diagrams shown within this Owner's Manual are representations of this model(s). Actual model may vary.

## What Are Infrared Rays?

Infrared is the band of light we perceive as heat. We cannot see this band of light with the naked eye, but we can feel this type of light in the form of heat. Our sun produces most of its energy output in the infrared segment of the spectrum. Infrared rays heat your body without having to heat the air in-between. This process is called conversion.

The infrared is divided into 3 segments by wavelengths measured in microns: Near Infrared – 0.76-1.5 microns; Middle Infrared – 1.5-5.6 microns; and Far Infrared – 5.6-1000 microns. Among these segments, Far Infrared penetrates organic substances such as the human body two to three inches so that the warming effect is very uniform.

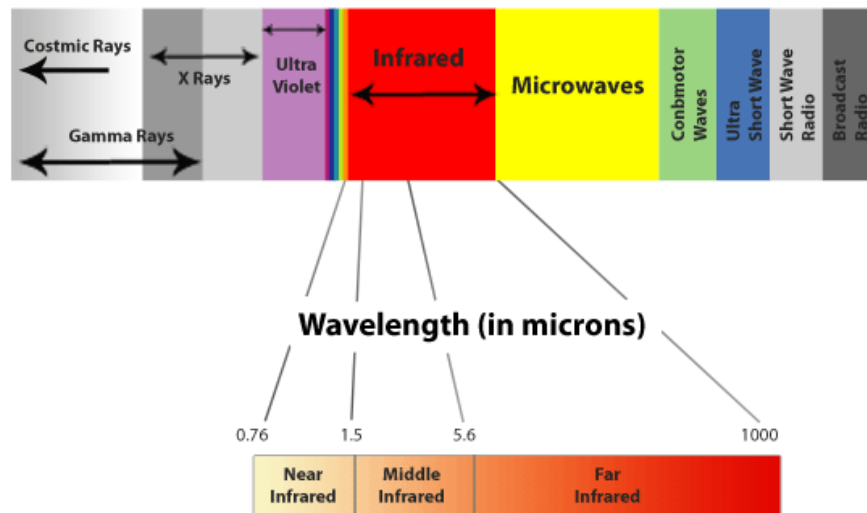

## ARE INFRARED RAYS SAFE?

Because infrared rays are part of sunlight, they are not only safe but also highly beneficial to our bodies on a cellular level. Health professionals have used infrared heat lamps for decades to **treat muscle and joint problems**. In hospital baby care units, incubators are often equipped with infrared heating systems to **keep newborn babies warm**.

## WHAT IS AN ELECTROMAGNETIC FIELD (also known as EMF)?

An Electromagnetic Field is a physical field produced by electrically charged objects. It is one of the fundamental forces of nature. The field can be viewed as the combination of an electric field and a magnetic field. The electric field is produced by stationary charges and the magnetic field by moving charges referred to as currents. The magnetic field is measured in milligauss (mG). Our sauna products have been developed to have low EMF. Our Ultra Low EMF sauna models range between 3mG-5mG at approximately 2 inches from the heater panels.

## EMF Levels from Common Homes Sources

SOURCE	mG up to 4 inches	mG at 3 feet
Blender	50-220	0.3-3
Clothes Washer	8-200	0.1-4
Coffee Maker	6-29	0.1
Computer	4-20	2-5
Flourescent Lamp	400-4,000	0.1-5
Hair Dryer	60-20,000	0.1-6
Microwave Oven	100-500	1-25
Television	5-100	0.1-6
Vacuum Cleaner	230-1,300	3-40
Airplane	50	

Source: USA Environmental Protection Agency

After many years and numerous studies on EMF exposure, no government body including the Occupational Safety and Health Administration (OSHA) have established permissible exposure limits (PEL). Currently, there is no consensus on the potential health hazard from any exposure to EMF. The mainstream scientific evidence suggests that low-power, low-frequency, electromagnetic radiation associated with household currents like that of the infrared sauna does not constitute a short or long term health hazard.

### DISCLAIMER

The infrared rays emitted by your sauna are reported to offer a wide range of possible therapeutic benefits based on research completed over the last 40 years from all around the world. These benefits are presented for reference purposes only and no implication of infrared saunas creating a cure for or treating any disease is implied nor should it be inferred. If you have a medical/health condition, are taking prescription drugs, or have acute joint injuries, please consult with your medical physician before using the sauna. Persons with surgical implants (metal pins/rods, artificial joints, silicone, or other types of surgical implants) typically do not experience any adverse effects, but should also consult their medical physician or surgeon before using the sauna room.

## HOW IT WORKS

Infrared Saunas differ from traditional saunas in that they use infrared radiant energy to directly penetrate into the body's tissue to produce perspiration. Traditional saunas use steam to heat the air inside the sauna, which then heats your body until you begin to perspire. In order for this to be effective, temperatures would need to reach in the upwards of 190 degrees Fahrenheit. Infrared saunas only need a temperature of up to 120 degrees Fahrenheit to obtain the same effect. This lower temperature makes the environment more tolerable and allows you to breathe easier.

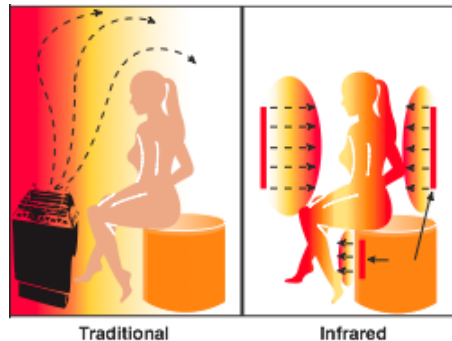

## Health Benefits

Because infrared rays penetrate the body through conversion, there is a deep heating effect in both the muscle tissues and internal organs without putting too much burden on the heart.

Our body reacts to the increased heating through the natural cooling process of perspiring. Through the perspiration process, acid and waste residue like toxins, sodium, alcohol, nicotine, cholesterol, and the potentially carcinogenic heavy metals are removed from the cells (especially zinc, lead, nickel, cadmium, etc.). The pores of our skin open and discharge waste products shedding any old skin cells leaving the skin glowing and clean, with improved tone, elasticity, texture, and color.

### Health Benefits Include, But Are Not Limited To:

- |  |                           |                     |
|--|---------------------------|---------------------|
| *Pain relief from Rheumatoid Arthritis | *Relaxes muscle spasms    | *Reduces cellulite  |
| *Increases blood circulation           | *Clears, rashes, acne     | *Enhances skin tone |
| *Cardiovascular conditioning           | *Reduces stress & fatigue | *Removes toxins     |

## Sauna Maintenance

Since infrared saunas do not require hot rocks, water, or steam to operate, they require very little maintenance. You can simply wipe it down with water – use a damp, soft, and clean cloth. **Do not use any chemical based cleaning agents** as they can be absorbed into the wood and be released into your sauna during use.

# READ ALL INSTRUCTIONS THOROUGHLY BEFORE ASSEMBLY

## Visual Assembly Diagram

DYN-6210-04 ELITE

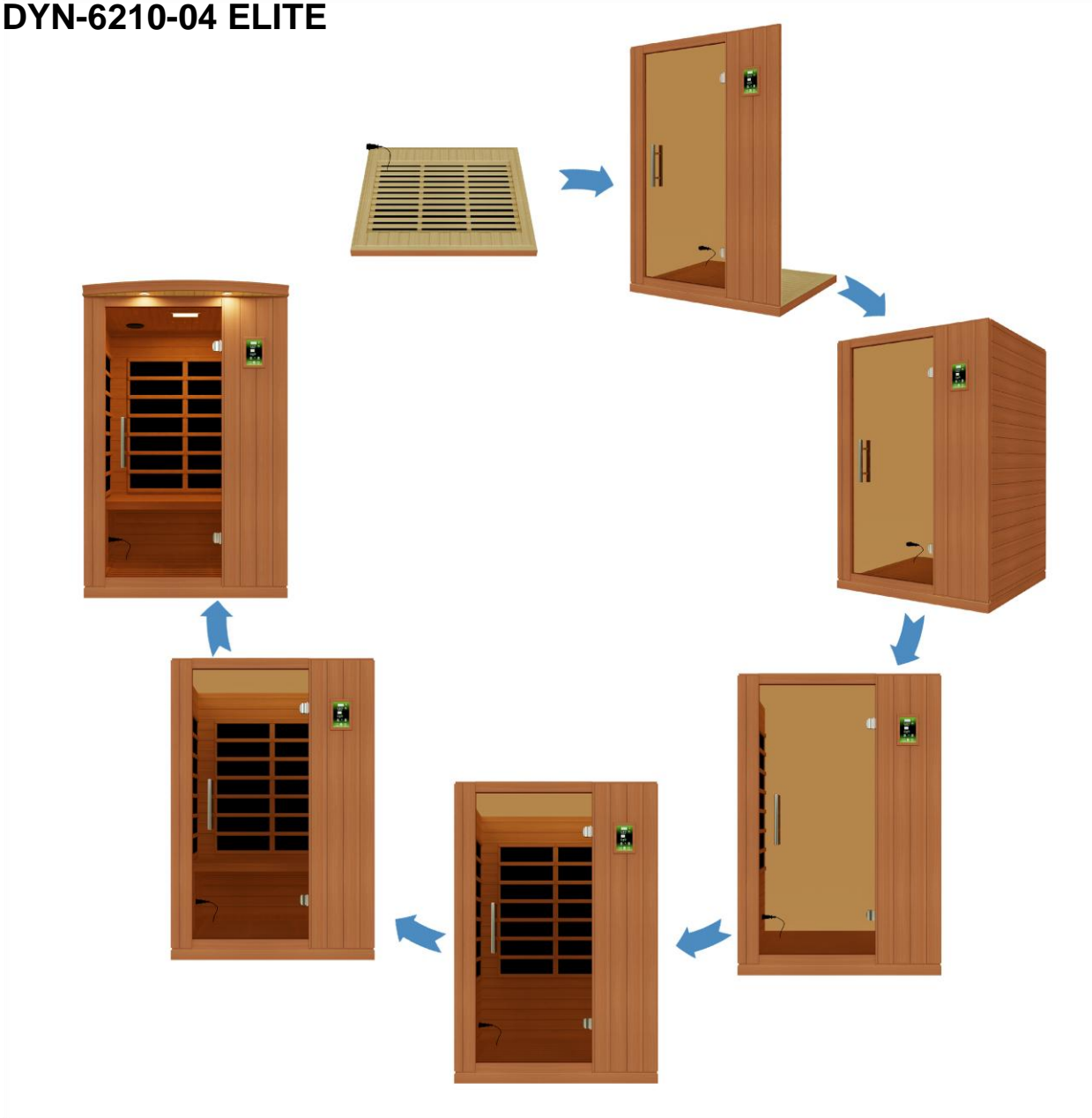

**\*THE ABOVE ASSEMBLY DIAGRAM IS FOR A QUICK REFERENCE VISUAL GUIDE ONLY. ALL SAUNA MODELS MAY NOT BE SHOWN. PARTS AND ACCESSORIES DO VARY AND ARE SUBJECT TO CHANGE. BACKRESTS NOT INCLUDED.**

# READ ALL INSTRUCTIONS THOROUGHLY BEFORE ASSEMBLY

## Visual Assembly Diagram

### DYN-6310-04 ELITE

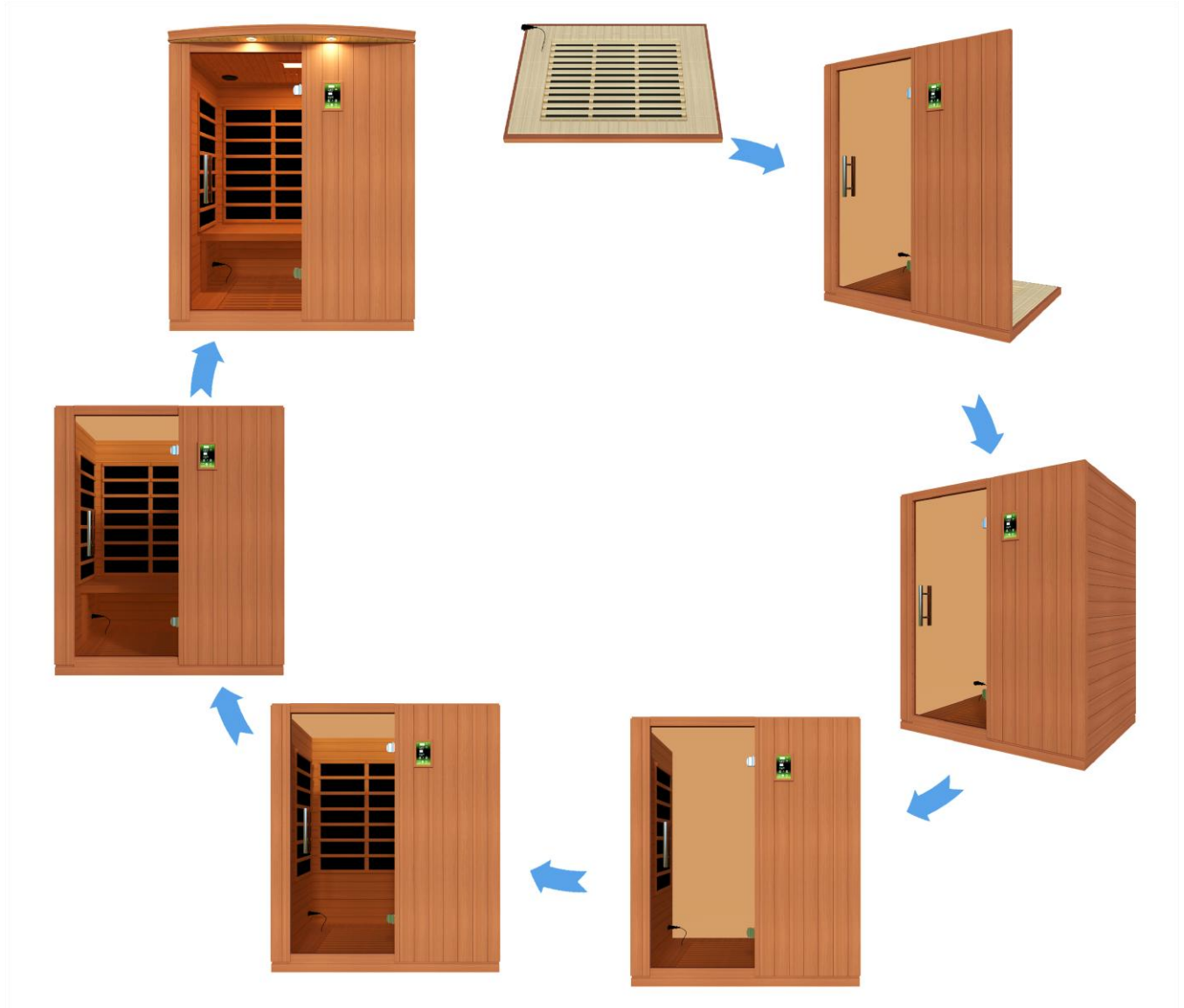

**\*THE ABOVE ASSEMBLY DIAGRAM IS FOR A QUICK REFERENCE VISUAL GUIDE ONLY. ALL SAUNA MODELS MAY NOT BE SHOWN. PARTS AND ACCESSORIES DO VARY AND ARE SUBJECT TO CHANGE. BACKRESTS NOT INCLUDED.**

# READ ALL INSTRUCTIONS THOROUGHLY BEFORE ASSEMBLY

## DYN-6210-04 ELITE – Schematics

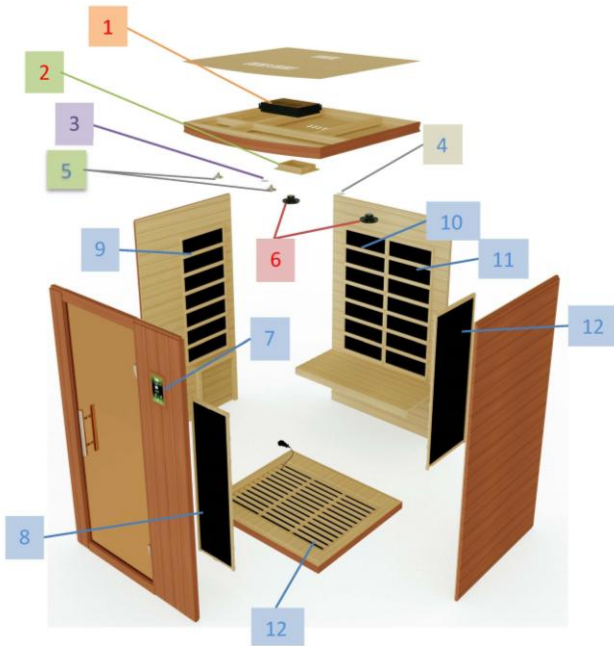

Electronic components			
No.	Name	No.	Name
1	Power supplier	2	Color Light w/Red Light Therapy
3	AUX MP3	4	Temperature sensor
5	Roof lights	6	Speakers
7	Control panel		

Power layout			
Location	No.	Dimension	Power
Front wall panel	8	1000*300mm	200W
Left side wall panel	9	1000*400mm	200W
Rear wall panel	10	1000*450mm	300W
	11	1000*450mm	300W
Right side wall panel	12	1000*400mm	200W
Floor panel	13	1000*600mm	400W
Total power			<b>1600W</b>

**\*THE ABOVE ASSEMBLY DIAGRAM IS FOR A QUICK REFERENCE VISUAL GUIDE ONLY. ALL SAUNA MODELS MAY NOT BE SHOWN. PARTS AND ACCESSORIES DO VARY AND ARE SUBJECT TO CHANGE. BACKRESTS NOT INCLUDED.**

# READ ALL INSTRUCTIONS THOROUGHLY BEFORE ASSEMBLY

## DYN-6310-04 ELITE – Schematics

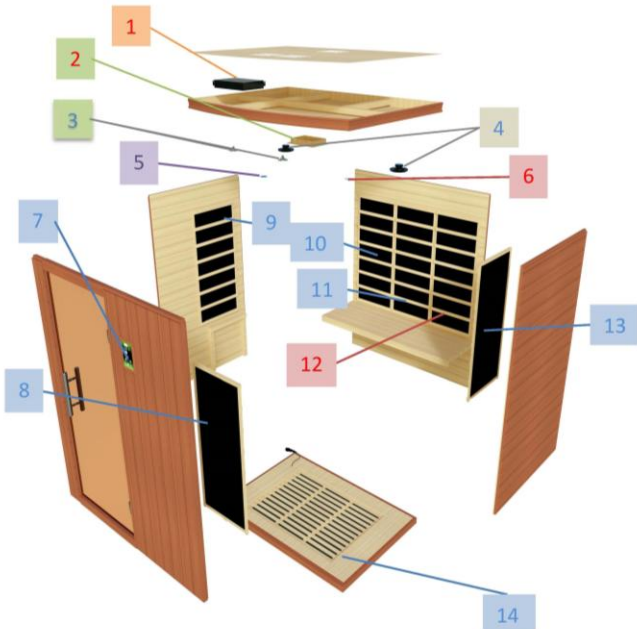

Electronic components			
No.	Name	No.	Name
1	Power supplier	2	Color Light w/Red Light Therapy
3	Roof lights	4	Speakers
5	Temperature sensor	6	AUX MP3
7	Control panel		

Power layout			
Location	No.	Dimension	Power
Front wall panel	8	1000*400mm	300W
Left side wall panel	9	1000*400mm	200W
Rear wall panel	10	1000*400mm	300W
	11	1000*400mm	300W
	12	1000*400mm	300W
Right side wall panel	13	1000*400mm	200W
Floor panel	14	1000*700mm	500W
Total power			<b>2100W</b>

**\*THE ABOVE ASSEMBLY DIAGRAM IS FOR A QUICK REFERENCE VISUAL GUIDE ONLY. ALL SAUNA MODELS MAY NOT BE SHOWN. PARTS AND ACCESSORIES DO VARY AND ARE SUBJECT TO CHANGE. BACKRESTS NOT INCLUDED.**

# READ ALL INSTRUCTIONS THOROUGHLY BEFORE ASSEMBLY

## DYN-6210-04 ELITE – Schematic Layout

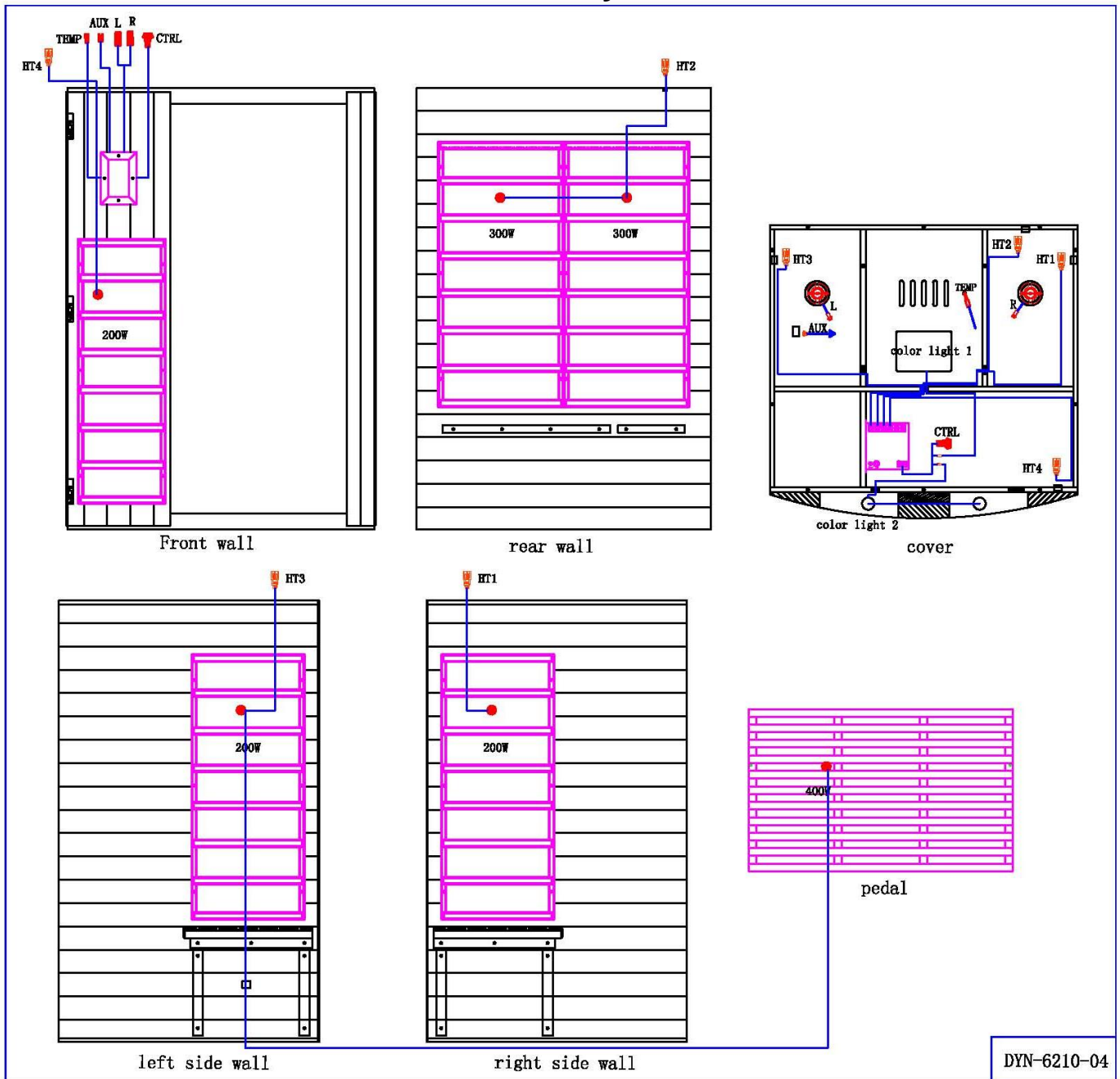

**\*THE ABOVE ASSEMBLY DIAGRAM IS FOR A QUICK REFERENCE VISUAL GUIDE ONLY. ALL SAUNA MODELS MAY NOT BE SHOWN. PARTS AND ACCESSORIES DO VARY AND ARE SUBJECT TO CHANGE. BACKRESTS NOT INCLUDED.**

# READ ALL INSTRUCTIONS THOROUGHLY BEFORE ASSEMBLY

## DYN-6310-04 ELITE – Schematic Layout



**\*THE ABOVE ASSEMBLY DIAGRAM IS FOR A QUICK REFERENCE VISUAL GUIDE ONLY. ALL SAUNA MODELS MAY NOT BE SHOWN. PARTS AND ACCESSORIES DO VARY AND ARE SUBJECT TO CHANGE. BACKRESTS NOT INCLUDED.**

# READ ALL INSTRUCTIONS THOROUGHLY BEFORE ASSEMBLY

## DYN-6210-04 ELITE – DIMENSIONAL DIAGRAM

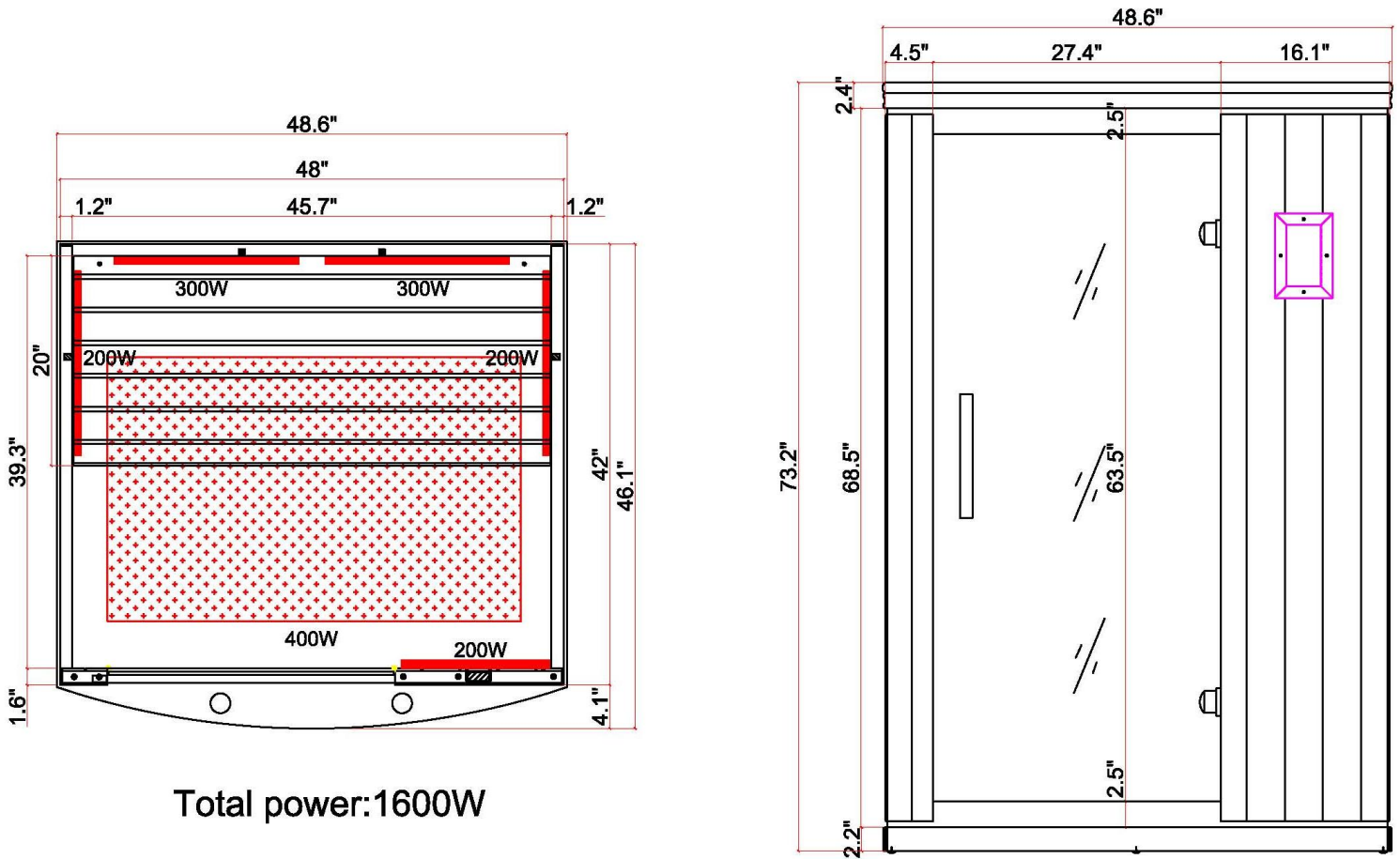

**\*THE ABOVE ASSEMBLY DIAGRAM IS FOR A QUICK REFERENCE VISUAL GUIDE ONLY. ALL SAUNA MODELS MAY NOT BE SHOWN. PARTS AND ACCESSORIES DO VARY AND ARE SUBJECT TO CHANGE. BACKRESTS NOT INCLUDED.**

# READ ALL INSTRUCTIONS THOROUGHLY BEFORE ASSEMBLY

## DYN-6310-04 ELITE – DIMENSIONAL DIAGRAM

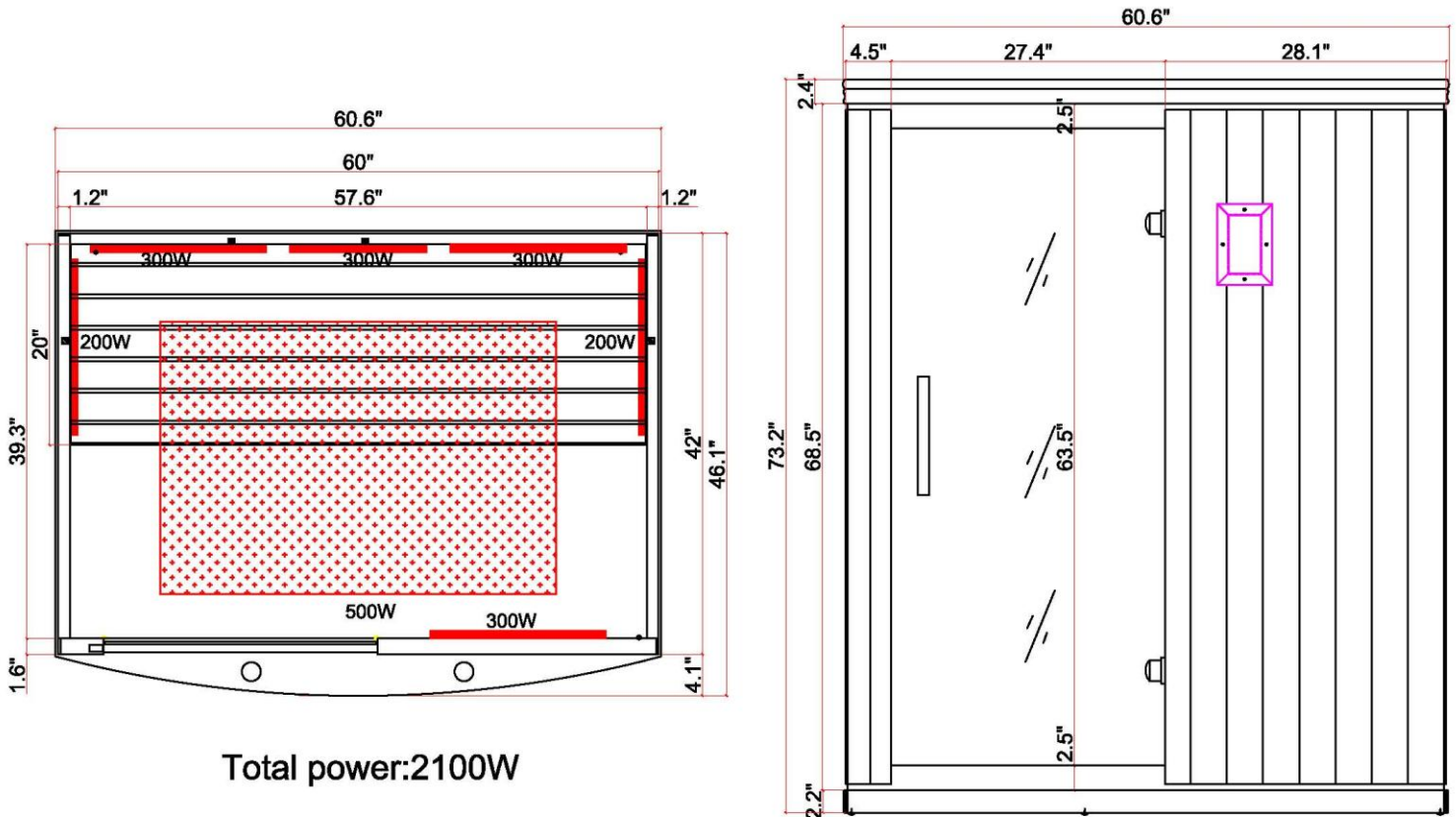

**\*THE ABOVE ASSEMBLY DIAGRAM IS FOR A QUICK REFERENCE VISUAL GUIDE ONLY. ALL SAUNA MODELS MAY NOT BE SHOWN. PARTS AND ACCESSORIES DO VARY AND ARE SUBJECT TO CHANGE. BACKRESTS NOT INCLUDED.**

# SCREW IDENTIFICATION AND LOCATION CHART



<b>DYN-6210-04 ELITE</b>		
LOCATION	SPECS	USAGE
ROOF COVER	3x18mm(wood screw-gold color)	12
MP3 SHELF	3x18mm(wood screw-gold color)	2
BENCH	3.5x40mm(wood screw-gold color)	2
ROOF PANEL	5x50mm(wood screw-gold color)	12
<b>DYN-6310-04 ELITE</b>		
LOCATION	SPECS	USAGE
ROOF COVER	3x18mm(wood screw-gold color)	12
MP3 SHELF	3x18mm(wood screw-gold color)	2
BENCH	3.5x40mm(wood screw-gold color)	2
ROOF PANEL	5x50mm(wood screw-gold color)	12

# Highlights

## I. Power Supply (Control Box)

The POWER SUPPLY is the control center of the sauna room. It is installed on the topside of the ROOF PANEL and has inputs/outputs connected to it. (see Figure 1)



Figure 1

- POWER IN** - main power of the sauna room
- HT1, HT2, HT3, HT4, HT5, HT6** – heat emitter cords
- LAMPROOF** – roof lamp power (optional)
- LIGHTING** – chromotherapy lights
- PANEL CONTROL** – control panel
- FUSE RESET** – protects against power

## II. Component Labeling

**Power Cord** – Main power cord connects the POWER SUPPLY to the dedicated wall outlet

**HT1, HT2, HT3, HT4, HT5, HT6** – Heater cords connect the heat emitters to the POWER SUPPLY at these ports (HT5 & HT6 are not used on most models)

**Lighting** – Connects the interior lighting to the POWER SUPPLY at this port

**LampRoof** – Connects the exterior roof lights to the POWER SUPPLY at this port

**Panel Control** – Connects the Control Panel through the CTRL harness to the Power Supply at this port

**L/R Speakers** – Connects the speakers through these wires to the Control Panel

**Temp Sensor** – Connects the Temperature Sensor through this wire to the Control Panel

### III. MP3 Auxiliary Port

The MP3 Auxiliary Port allows you to connect a MP3 player or other device with the auxiliary function to the speakers in the sauna room for your listening pleasure. (see Figure 2)



Figure 2

### IV. Buckles

#### A. External Buckles

The external buckles are used to connect the LEFT and RIGHT SIDE PANELS to the REAR PANEL. (see Figure 3)

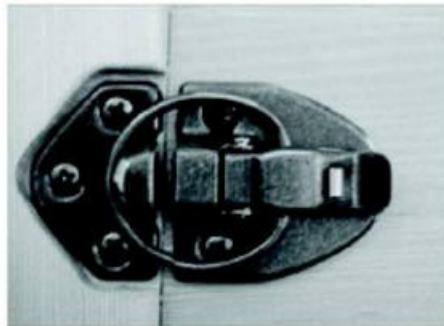

Figure 3

#### B. Guide and Guide Inserts

The guide and guide inserts are used to connect the FRONT PANEL to the LEFT SIDE PANEL and the RIGHT SIDE PANEL. (see Figure 4)

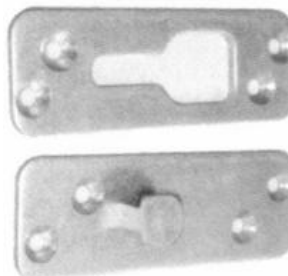

Figure 4

## V. Panel Descriptions

For easier installation, please understand and distinguish the differences between each panel.

### A. Floor Panel

When the floor panel faces upward, you will find the floor heater towards the front of the sauna room. (see figure 5)

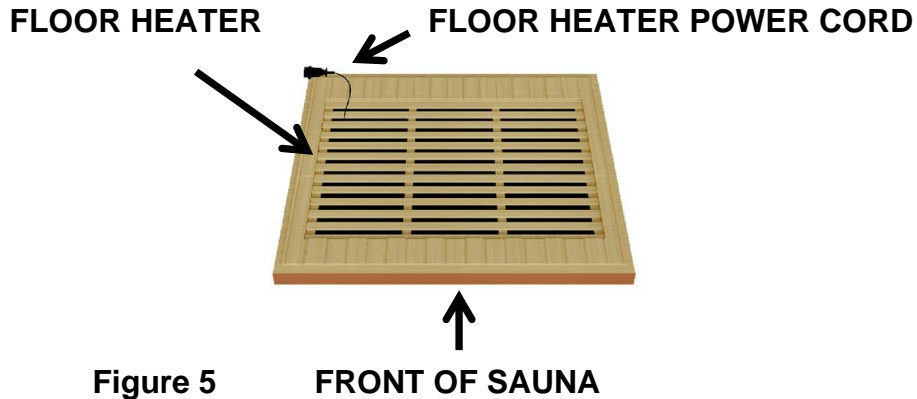

Figure 5

### B. Understanding The FRONT and REAR WALL PANELS

The REAR WALL PANEL and the FRONT WALL PANEL with the GLASS DOOR are the largest of the wall panels. The REAR WALL PANEL has HEAT EMITTER PANELS. The RIGHT SIDE WALL PANEL and LEFT SIDE WALL PANEL are the same size and also have HEAT EMITTER PANELS. (see figure 6 and 6a)



FRONT WALL PANEL  
PANEL

Figure 6



REAR WALL

Figure 6a

### **C. Rear Panel**

The rear panel is the panel with the buckles. The buckles are mounted on the outside of the rear panel. (see figure 7)



**Figure 7**

### **D. Understanding The Difference Between The Inside And Outside Of The Rear Panel**

You will find the heat emitters on the inside of the rear panel.

## **Assembly Instructions**

### **A. Choose a good location to install the sauna**

1. The location must be dry, leveled, and away from any source of water
2. MAIN POWER cord must be easily accessible
3. Two adults are required for installation
4. Wood cabin installation order: Floor Panel ► Front Panel ► Right Side Panel ► Left Side Panel ► Rear Panel ► Bench ► Roof Panel ► Roof Cover
5. Tools Required: Philips Screwdriver and Ladder

## B. Installing the FLOOR PANEL

1. Place the FLOOR PANEL on the floor. Make sure the front of the FLOOR PANEL is facing the correct direction. (see Section V. Panel Descriptions)

## C. Installing the FRONT PANEL, SIDE PANELS, and DOOR HANDLE

1. Place the FRONT PANEL onto the recessed area on the FLOOR PANEL. Align the guides on the RIGHT SIDE PANEL with the guide inserts on the FRONT PANEL. The RIGHT SIDE PANEL will need to be lifted in order to lock the guide inserts on the FRONT PANEL into the guides on the RIGHT SIDE PANEL. Secure in place by pulling down on the RIGHT SIDE PANEL. Make sure all the guides are locked in place and the top of the RIGHT SIDE PANEL is even with the FRONT PANEL. Do the same for the LEFT SIDE PANEL. (see figure 8)



Figure 8

**NOTE:** If any of the wall panels do not slide all the way down, then follow this tip:

1. First, remove the side wall panel.
2. Locate the guide and guide insert brackets on the two wall panels (6 pieces total).
3. Loosen the screws on the guide and guide insert brackets by two-to-three turns (so the guide and guide inserts have a slight movement)
4. Reattached the wall panels.

The above will help as sometimes the guide and guide insert brackets are

countersunk too deep. Please note that the guide and guide insert brackets slide together at an angle - as the wall panels slide downward, the guide and guide insert brackets pull the wall panels tighter together.

2. Now that the FRONT WALL PANEL has already been installed, the inner and outer door handles need to be mounted to the FRONT GLASS DOOR. According to Figure 9 - Figure 11, the FRONT GLASS DOOR must sit between the (2) white washers. The screws are inserted from the inside of the FRONT GLASS DOOR and screwed into the outer handle. **BE SURE NOT TO OVER TIGHTEN THE SCREWS OR YOU WILL SHATTER THE FRONT GLASS DOOR.** Next, the inner door handle needs to be inserted over the screws. Used the provided Hex Wrench to tighten the (4) hex screws. See Figure 11. Do remove the black plastic transport corners from the corners of the glass door.



Figure 9



Figure 10



Figure 11

#### D. Installing the REAR PANEL

1. Remove the protection paper from the buckles (tape). Place the REAR PANEL onto the FLOOR PANEL. Attach the REAR PANEL to the SIDE PANELS and buckle together. (see figure 12)

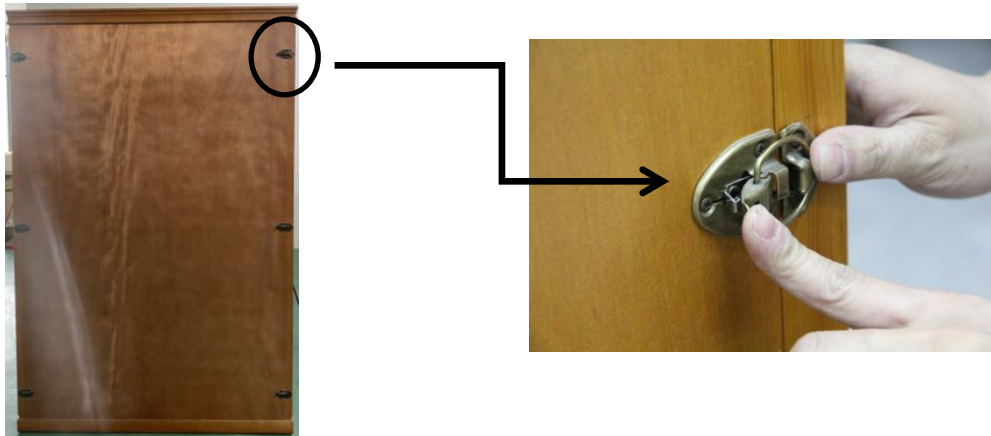

Figure 12

#### E. Installing the BENCH

1. Install the BENCH by sliding it over the horizontal bench guides on the side panels. Push the BENCH all the way in until it touches the REAR PANEL and is secured in place. Make sure to install the BENCH with the smooth and finished side facing up. Use the 3.5x40mm screws to screw the BENCH down and secure it in place. (See Figure 13)



Figure 13

## F. Installing the ROOF PANEL

1. The side of the ROOF PANEL with the power supply box faces upward.
2. The edge nearest the power supply is the front of the ROOF PANEL. Be careful of the wires coming from the REAR PANEL when you set the ROOF PANEL down onto the panels. Feed the wires through the holes in the ROOF PANEL. Do the same for any wiring harnesses coming from the SIDE or FRONT PANELS.
3. Be careful not to force the ROOF PANEL into place. Make sure that the wires are properly fed through the holes.
4. When all the wires are fed through their appropriate holes, lower the ROOF PANEL into place.
5. The four screws taped to the four sides of the ROOF PANEL are used to mount the ROOF PANEL to each of the wall panels. This is optional and not necessary for home installation. Use the pre-drilled holes on the four sides of the ROOF PANEL.

## G. Connecting the plugs on the ROOF PANEL

1. Connect the plugs according to the respective labels. (see figure 14 &15)
2. Connect the CTRL connection from the power supply to the CTRL connection from the control panel. (see Figure 14 & 15)



Figure 14



Figure 15

## H. Installing the TEMPERATURE SENSOR

1. Enter the sauna and remove the protective masking tape from the TEMPERATURE SENSOR if the TEMPERATURE SENSOR is taped to the ceiling. Situate the TEMPERATURE SENSOR so that it is vertical, pointing downward. (see Figure 16)



Figure 16

**Note:** Some sauna models are shipped with a spare TEMPERATURE SENSOR in case the TEMPERATURE SENSOR is damaged in transit. The manufacturer decides this according to sauna models and packaging.

## I. Putting on the ROOF COVER

1. Place the ROOF COVER over the top of the sauna. Be cautious when pulling the power cord through the hole in the roof cover. Gently place the ROOF COVER onto the ROOF PANEL. When the edges are aligned, screw the ROOF COVER to the roof panel. (see Figure 17)



Figure 17

## J. Installing the MP3 SHELF (optional)

1. Locate the MP3 SHELF. Use the two screws provided to mount the shelf on either the side panels or front panel. (see Figure 18)



**Figure 18**

## **Assembly Complete**

### **Operating the Sauna**

**NOTE: Before the sauna is turned on, remove plastic protective covering from the CONTROL PANELS. Please check and confirm that the connections to the POWER SUPPLY (including the power cord), HEAT EMITTERS, CD/RADIO, and TEMPERATURE SENSOR are connected properly and are snug and tight. The power supply voltage and frequency must match the requested voltage and frequency of the sauna (120VAC 15AMP Dedicated Circuit or 120VAC 20AMP Dedicated Circuit). Please consult a certified electrician for any electrical modifications or repairs.**

**Since many materials absorb the infrared rays, minimal clothing is recommended for maximum effect. The infrared sauna emitters are designed to heat you and not necessarily the air inside the sauna. It is not a hot box like a traditional sauna. The temperature gauge is a guide for your safety. It is recommended that you drink water before, during, and after sauna use to prevent dehydration since body fluids will be lost through perspiration. It is not recommended to shower immediately after use since the pores in your skin will be open and could possibly absorb anything in the water.**

## CAUTION: Exit Sauna Immediately If You Feel Dizzy, Sleepy, Or Any Discomfort.

### Control Panel

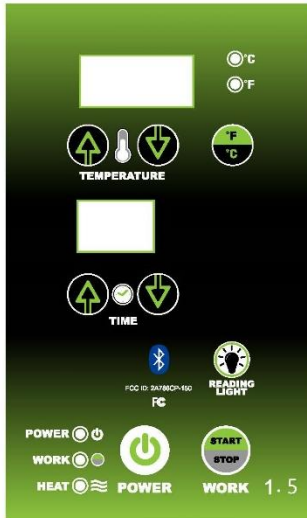

**Power On/Off:** Press to control the main power of the sauna

**Power Indicator:** Indicates the status of the sauna's main power

**Work Start/Stop:** Press to control the working functions of the sauna

**Work Indicator:** Indicates the working status of the sauna

**Heat Indicator:** Indicates the status of heating function

**Light:** Press to control the lighting function

**Time Display:** Displays the heating time of the sauna in minutes

**Time:** Press to adjust the setting of the timer

**Temperature Display:** Displays the actual interior temperature of the sauna room in  $^{\circ}\text{C}/^{\circ}\text{F}$

**Temperature:** Press to adjust the temperature setting

**$^{\circ}\text{C}/^{\circ}\text{F}$ :** Press to change the temperature display between  $^{\circ}\text{C}/^{\circ}\text{F}$

1. Plug the sauna into the wall outlet.
2. Press the POWER button once. The POWER light will come on, the TIME DISPLAY will show 90 (minutes), the TEMPERATURE DISPLAY will show  $151^{\circ}\text{F}$  /  $66^{\circ}\text{C}$ , and the control panel will flash.
3. Press the up/down arrows under the TIME DISPLAY to adjust the amount of time you want the sauna to remain on. Press the C/F button to choose between Celsius and Fahrenheit. Press the up/down arrows under the TEMPERATURE DISPLAY to adjust the temperature setting. Once you have set these adjustments to the desired settings, press the START/WORK button. If you do not press the button for 5 seconds, the control panel will stop flashing and the set-up values will be memorized. The WORK and HEAT lights will now be on and the emitters will now be generating heat. You can either pre-heat the sauna to the set temperature before entering or sit inside the sauna as the temperature rises to the set temperature. Please keep in mind that you will increase the time it takes for the sauna to reach the set temperature if you enter the sauna room before it has reached the set temperature.
4. During your sauna session, set-up time will count down the minutes one by one. You can use the up/down arrows to adjust the time. If you do choose to adjust the time, the control panel will flash and the emitters will stop generating heat. Once

you set the time to the desired setting, then press the START/WORK button twice and the control panel will stop flashing and heat will began coming from the emitters once again.

5. Heating times do vary. Generally, it will take approximately twenty to thirty minutes to preheat the sauna to the average used temperature range of approximately 118 degrees Fahrenheit / 48 degrees Celsius. When the ambient temperature is low, heating requires additional time. For the first few times of use, you may use 115 degrees Fahrenheit / 46 degrees Celsius as a reference starting point for a time period of about 20 to 30 minutes (this represents the actual time you are in the sauna at the desired temperature). As you become more comfortable and familiar with the sauna, you can increase the temperature and time period according to your personal preference.
6. When the temperature is at the set-up value, the digital control will maintain the set temperature. The WORK light will remain on and the HEAT light will turn off. The emitters will stop generating heat. Once the inside temperature drops approximately 4 degrees Fahrenheit, the HEAT light will turn back on and heat will again be generated by the emitters. With the digital control, the inside temperature will always remain around the set-up value.
7. Reading lamps and/or roof lamps and/or color therapy lamps are operated by pressing the respective buttons located towards the center of the control panel. These lamps are offered on some models and are not available on all models.
8. **Color Lighting** can be operated as follows: First, you will need to install the battery. Once the battery has been inserted into the remote, you are ready to operate the color therapy lighting system . Press the READING LIGHT button on the sauna control panel. The white light will come on. While pointing the remote at the ceiling light, you can press any of the colors on the remote and that color will be displayed. You can use the SHADE button on the remote to go through a sequence of colors. If you want to turn the light off during your sauna session, you can press the POWER button on the remote. **Please note: You must be inside the sauna room for the remote to work.**



**Please note that the lights and music will remain ON for approximately 15**

**minutes when the time on the control panel has timed out. (Available on some models, but not all models)**

9. **Red Light Therapy (optional)** works with the Color Lighting system. When the Color Light is ON, you can press the white button at the bottom right of the Color Light Remote once to turn on the Red Light Therapy feature. To exit the Red Light Therapy feature and return back to the white reading light, just press the white button at the bottom right of the Color Light Remote once again and press the button of the specific color or the shade button to go through the sequence of colors.
10. **Bluetooth** can be used on the sauna room. You first will need to pair your device with the sauna room. Open your device's Settings Menu and then locate and open Bluetooth. You will find "iSauna" or "BT100" or "Bluetooth". Now you can pair your device. Once pairing is successful, your device will be connected. Please note that you must unpair/disconnect from Bluetooth if your sauna model has the optional MP3 Jack at the ceiling and you choose to use the Aux Wire to connect to the speaker system. If you need to reset the Bluetooth/Aux system, you can do so by unplugging the sauna's power cord for 15 minutes.
11. **The MP3 Jack** will allow you to connect your musical device using the AUX wire. Plug one end of the AUX wire into your musical device and the other end into the MP3 Jack at the ceiling. Do not leave the AUX wire connected at the ceiling when not using this function as it may cause static interference at the speakers. You will control the volume and choose the music on your device. When you disconnect the MP3 wire, the sound system will automatically return back to the Bluetooth mode.

**Please Note: On average, it takes our model saunas approximately:**

**\*20 minutes to reach into 100 degrees Fahrenheit/38 degrees Celsius (with a Starting temperature above 70 degrees Fahrenheit/21 degrees Celsius)**

**\*25-30 mins to reach about 115-120 degrees Fahrenheit/46-49 degrees Celsius (depending on sauna model)**

**\*35-40 minutes to reach about 125-130 degrees Fahrenheit/52-54 degrees Celsius (depending on sauna model)**

**\*45-60 minutes to reach up to approximately 135 degrees Fahrenheit/57 degrees Celsius (depending on sauna model)**

**Please keep in mind that you can either preheat the sauna to the set temperature before entering or sit inside the sauna as the temperature rises. In addition, you**

will increase the time it takes for the sauna to reach the set temperature if you enter the sauna room before it has reached the set temperature. Also, the most commonly used temperature setting is between 118 degrees Fahrenheit / 48 degrees

Celsius and 122 degrees Fahrenheit / 50 degrees Celsius. The way the sauna room works is when you set the Control Panel to say 120 degrees F / 49 degrees C, the heat emitters will turn off when that set temperature is reached. And even though the sauna does allow the user to set the Control Panel to 151 degrees F/66 degrees C, this is specifically for those users who do not want the heat emitters to ever turn off as the sauna room will never achieve 151 degrees F / 66 degrees C. After 3 hours of continuous use, the sauna needs to be shut down for one hour.

Use 2 towels during your sauna session. Fold the first towel several times and place it on the bench. As you sit on this towel, it will absorb a majority of your perspiration while adding comfort as you sit on the bench. Use the second towel to either constantly wipe the perspiration from your body to perspire faster and also to avoid having too much perspiration dripping onto the floor. Never place any towels over the floor heater. If your legs become cold, you can use a third towel to drape over your legs to trap the heat.

### **Maintenance:**

With regards to maintenance, you do not want to use any liquid cleaners or aerosol cleansers inside the sauna. Unplug the sauna from the wall outlet before cleaning. Use plain water and a soft cloth for cleaning. Clean floor heater regularly to keep free of debris. ***Do not use benzene, alcohol, or strong cleaning chemicals in or on the sauna. NOTE: Any chemical that can damage wood or be absorbed into the wood will damage the sauna.***

**CAUTION: Exit sauna immediately if you feel dizzy, sleepy, or any discomfort.**

### **Tips for using Your Sauna**

1. If you take a hot/warm shower or bath before using your sauna, you may perspire more and experience more comfort.

2. Drink water prior to, during, and after your sauna session to replenish body fluids.
3. To regulate the set temperature inside the sauna to your comfort level, use the movable roof vent or leave the door slightly open. The roof vent is installed on the sauna and used based on personal preference.
4. Use 2 towels during your sauna session. Fold the first towel several times and place it on the bench. As you sit on this towel, it will absorb a majority of your perspiration while adding comfort as you sit on the bench. Use the second towel to either constantly wipe the perspiration from your body to perspire faster and also to avoid having too much perspiration dripping onto the floor. Never place any towels over the floor heater. If your legs become cold, you can use a third towel to drape over your legs to trap the heat.
5. This is a non-commercial sauna. For every three hours ON, the sauna must be turned OFF for one hour to cool down.
6. At the first sign of a cold or flu, increasing your sauna sessions may be beneficial in boosting your immune system and decreasing the reproductive rate of the virus.
7. To help relieve sore and tense muscles, massage the affected areas during your sauna session.
8. To treat your ankles and feet more effectively, you can elevate them and move them close to one of the heat emitters to achieve a deep heating effect.
9. To utilize the sauna's heat therapy effect, put oil and treatment into your hair and wrap it with a towel. After your sauna session is over, rinse your hair thoroughly.
10. The peaceful and relaxed state rendered by a sauna session may help you to sleep easier and deeper.
11. To conserve energy consumption, please unplug your sauna when not in use – especially if you do not plan on using the sauna for an extended period of time.
12. After the sauna session is over, do not jump into the shower or bath immediately. Because your body was heated up during the sauna session, it will continue to perspire even after the heat emitters are off. Sit in the sauna with the door slightly opened and let your body cool down. Once your body has cooled down and you feel comfortable, you can exit the sauna. After about fifteen minutes and when your body has completely cooled down, you can take a shower or bath to clean your body.

## **Safety Instructions**

1. Read and follow all instructions carefully before using the sauna.
2. When assembling and using the electrical equipment, safety precautions should always be followed.
3. To reduce the risk of injury, do not allow children to use the sauna unless they are closely supervised at all times by an adult. Children should not use the sauna unless prescribed or advised by their medical doctor.
4. Do not use the sauna immediately following strenuous exercises. Wait at least 30 minutes to allow the body to cool down completely.

5. Pregnant or possibly pregnant women should contact their medical physician prior to using the sauna. Excessive temperatures have a high potential for causing fetal harm during pregnancy.
6. **Hyperthermia Danger:** The normal body temperature can't rise above 103°F (39°C). Symptoms of excessive hyperthermia include dizziness, lethargy, drowsiness, and/or fainting. The effects of excessive hyperthermia may include, but are not limited to failure to perceive heat, physical inability to exit the sauna, unawareness of impending hazards, unconsciousness, and/or fetal harm in pregnant women. Hyperthermia could make your body's core temperature rise. Setting the desired temperature to an excessively high temperature is not recommended.
7. The use of alcohol, drugs, or medications (prescribed or non-prescribed) prior to or during the sauna session may lead to unconsciousness and/or other harmful physical injuries.
8. Persons suffering from obesity or with a medical history of heart disease, low or high blood pressure, circulatory system problems, diabetes, or other medical conditions should consult with a medical physician prior to using the sauna.
9. Persons using medications should consult with a medical physician before using the sauna. Some medications may induce drowsiness while other may affect the heart rate, blood pressure, and/or blood circulation.
10. Use care when exercising before and after sauna use.
11. Never sleep inside the sauna
12. Do not use any type of cleaning agents on the interior of the sauna. Only wipe down the sauna room with water and a damp cloth. Never use any chemical based cleaners.
13. Do not stack or store any objects on top of or inside the sauna.
14. If the power supply cord becomes damaged, it must be replaced immediately by the manufacturer or its agent. If you find the power cord is too hot (normally it will become warm) or that the electrical equipment may be experiencing technical problems, please contact the manufacturer or its agent immediately to avoid hazardous situations.
15. Make sure that the electrical outlet is in good working order. A common problem with electrical outlets is loose wiring on the connection points of the terminals of the outlet. A loose wire will also make for a bad connection and cause an unusual amount of heat buildup. Loose connections can also cause sparking in the junction box that can result in arcing. You'll likely see burn marks around the terminals if this occurs. If this happens, do not use the sauna and have the outlet replaced by a certified electrician. If the power cord is damaged, please contact Customer Support.
16. Do not use the sauna during an electrical storm to avoid risk of shock or injury.
17. Do not continuously switch the power ON and OFF excessively as it will compromise the life of the electrical components.
18. Your hands must be dry and free of moisture before plugging and unplugging cords and wiring harnesses from the power supply and circuit boards. Never operate the sauna with wet hands or wet feet to avoid the risk of electrical shock or injury. Never touch the metal prongs of the plug.

19. Do not attempt to make any repairs yourself unless authorized by the manufacturer or its agent. If a problem occurs with the sauna, please contact the manufacturer or its agent immediately to avoid safety risks. Unauthorized repair attempts will void the manufacturer's warranty.
20. Please make sure the outlet power supply meets the specifications required. Failure to meet the requirements may cause safety risks.
21. Some sauna models are equipped with reading and/or roof lamps. Because the lamp temperature will become very hot once powered ON, do not attempt to touch the lamp to avoid being burned. Do not attempt to touch it for at least 20 minutes or until it cools down completely if a need to touch it arises.
22. Do not pour water or any other liquids onto the infrared heat emitters. Do not bump, hit, or break the heating elements as it may cause an electrical short and pose a safety risk.
23. Do not make any modifications to the sauna, the sauna structure, or the sauna components.
24. Prior to each sauna session, the sauna room is to be inspected for correct operation. If for any reason your sauna does not seem to be operating properly, discontinue use and contact Customer Service.

## **Safeguards For Your Sauna**

1. Do not install the sauna near water, near a bathtub (if water will splash on the sauna), near a shower (if water will splash on the sauna), in a wet basement, or near a swimming pool (if water will splash on the sauna).
2. Do not use liquid cleaners or aerosol cleaners on the sauna. Unplug the sauna from the wall outlet before cleaning. Use plain water and a soft damp cloth for cleaning.
3. The power supply cord should be routed so that it is not walked on or pinched by any object that may be placed against it.
4. When replacement parts are required, be sure they meet the specified requirements of the manufacturer. Unauthorized substitutes may result in a fire, electrical shock, or other hazardous situations. After any repairs, please ask the service technician to perform a safety check to determine that the sauna is in good working order.
5. Do not use any wall receptacle adapter, surge protector, or extension cord between the sauna cord and wall outlet.

## **Troubleshooting**

**Before any troubleshooting of the sauna, make sure to unplug the sauna's power cord from the wall outlet. If the sauna is hard wired straight to the breaker in the Electric Panel, turn the breaker to the "OFF" position.**

### 1. Cannot Locate the Owner's Manual

**Solution:** The Owner's Manual is included in the Accessory Box. The accessory box is located in the roof panel. Please remove the thin hardboard roof cover to gain access to the Accessory Box.

### 2. Assembly

**Solution:** We do have an assembly video on youtube.com. The video may not be of the particular model you purchased, but our saunas do assemble in a similar fashion. Here is the web address to the video:  
<https://www.youtube.com/watch?v=2p-ib6Mwnoc>

### 3. No Heat Coming From Some of the Heat Emitters

**Solution:** Check to make sure all the heat emitter cords are properly connected, including the cord to the heat emitter underneath the bench (if applicable). Go to the roof, and also check that the heat emitter cords are properly connected snug and tight to the cords on the roof and that those cords are properly plugged into the power supply (snug and tight).

**Solution:** If some of the heat emitters are working, then the ones which are not working may have been damaged or are not properly connected. Check that the heat emitter cords are properly connected snug and tight. If the issue continues, then the particular heat emitter may be damaged. Do not continue to operate. Contact the manufacturer for replacement parts.

**Solution:** If the heat emitters are not working and there is a "-L" for the temperature reading, then the temperature sensor may not be plugged in properly or it may be damaged or the power supply may be defective. Go up to the rooftop of the sauna and locate the temperature sensor connection wires near the air vent towards the rear of the sauna. After you have located the wires labeled "TEMP SENSOR", disconnect the connection and reconnect the connection. If you have a second person available, please have them continue to look at the control panel as you disconnect and reconnect the temperature sensor connection to see if the "-L" changes at any time. If the "-L" disappears and reappears, then there may be an issue with the connection. Please contact Customer Service for assistance.

### 4. Control Panel Malfunctioning

**Solution:** If the control panel is showing no signs of power, then there could be a connection issue of the "CTRL" harness up on the roof. Go up to the roof and locate the "CTRL" wire harness you connected when the roof was installed onto the sauna room. Disconnect the "CTRL" wire harness and firmly reconnect the "CTRL" wire harness making sure it is snug and tight. Attempt to turn the sauna on at the control panel and check to see if the buttons are now responding. Contact the Customer Service for any additional troubleshooting.

**Solution:** If the control panel is showing no signs of power, then there could be a connection issue of the “CTRL” harness behind the control panel. You will need to remove the wood frame holding the control panel in place to gain access to the “CTRL” connection behind the control panel. Once you remove the control panel from the wall panel, you can disconnect and reconnect the connection making sure it is snug and tight.

**Solution:** If the control panel is showing no signs of power, check the sauna power cord at the wall outlet to make sure it is plugged in snug and tight. Also check your main circuit breaker to confirm that it has not tripped. Check the power supply on the roof of the sauna to make sure there are no signs of malfunctioning, such as a high temperature, burning odor, or strange sounds. Also, check to make sure none of the power cords are damaged. If the power supply is malfunctioning or power cords are damaged, then unplug the sauna immediately and contact the Customer Service.

**Solution:** The control panel will not turn off, the power/work/or heat lights do not come on, or the temperature and timer buttons do not work means the control panel may have been damaged and will need to be replaced. Before contacting Customer Service, remove the wood frame holding the control panel in place to gain access to the “CTRL” connection behind the control panel. Once you remove the control panel from the wall panel, you can disconnect and reconnect the connection making sure it is snug and tight.

Contact Customer Service for any additional troubleshooting.

**Solution:** If your sauna is plugged in and you have no power at the control panel, then the power supply may need to be reset. Go to the roof of the sauna and locate the power supply. Press the RESET button to reset the power supply. The RESET button is on the same side of the power supply as the power cord. Attempt to turn the sauna ON at the control panel.

Contact the manufacturer for any additional troubleshooting if necessary.

**Solution:** There could be damage to the temperature sensor. If your sauna arrived with a spare temperature sensor, turn the control panel off and go to the roof of the sauna and locate the red and black wire near the air vent

towards the rear of the sauna. After you have located the red and black wires labeled “TEMP SENSOR”, disconnect them. Connect the spare temperature sensor. For testing purposes, insert the “TEMP SENSOR” (you just connected) down the vent on the roof so that it is now inside the sauna. Then go to the control panel and press the power button. If the

heat emitters now heat, then the temperature sensor was the cause of the problem. You may have to wait about five minutes to confirm if the heat emitters are generating heat. Remove the original temperature sensor from its hole and replace it with the spare one.

**Solution:** If your control panel displays “-L”, it may be an error code and we assume both control panels are displaying this. If so, then it means there is a communication issue between the control panel, power supply, and temperature sensor. Please proceed to the following:

**Step A:**

1. Reconnect the sauna’s power cord. Make sure the control panel is turned ON. Two individuals will be needed. One individual will continuously watch the "-L" on the control panel to see if it changes while a second person goes up to the roof and locate the "PANEL CONTROL" harness connection that was connected during the assembling of the sauna room. Check both ends of this connection including at the power supply box.
2. Disconnect the "PANEL CONTROL" harnesses (both ends) and then reconnect making sure that the connection is snug and tight.
3. Also and while up on the roof, please located the temperature sensor wire. The temperature sensor is the black probe that is sticking out of the interior ceiling above your head as you sit on the bench. Disconnect the connection and reconnect to make sure the connection is snug and tight.
4. The individual watching the control panel can let you know if the "-L" ever changed. If the "-L" is still displayed on the control panel, then we need to rule out a control panel issue. Please proceed to **Step B**.

**Step B:**

1. Make sure to first unplug the sauna’s power cord from the wall outlet or power source. If the sauna is hard wired straight to the breaker in the Electric Panel, turn the breaker to the “OFF” position.
2. Remove the exterior wood frame around the exterior control panel. Simply unscrew the screws holding the wood frame on.
3. Once the wood frame has been removed, lift the control panel up and out. On the backside of the control panel, you will see a connection plug. This connection plug needs to be removed. In some cases, there is a plastic tie that holds the connection plug in place during shipment. This tie will have to be cut before the connection plug can be unplugged. You do not need to replace this tie. There are several connections, but you only have to be concerned with the black connection. You want to unplug by pulling the male connection from the female connection. Reconnect to make sure the connection is snug and tight. Leave the control panel hanging from the wall panel (do not replace with the wood frame as of yet).
4. Next, you can plug the sauna room back into the wall outlet or turn the breaker back “ON”. Test the control panel to see if it is responding and

working properly or if the "-L" is still displayed. If the control panel is responding and working properly, then it was a connection issue causing the problem and you can put back the control panel and wood frame.

**Solution:** Unfortunately, our saunas cannot be connected to a GFCI due to the amount of power the sauna uses. We have had customers who have connected their sauna to a GFCI protected outlet for the first time or for many months and then all of a sudden the GFCI starts causing the sauna to trip or just not turn ON at all. We do not have an answer as to why the GFCI was fine in the beginning when supplying power to the sauna and then suddenly starts causing problems for the sauna power supply. We recommended not connecting the sauna power cord to a GFCI protected outlet.

## 5. Wall Outlet Melting

**Solution:** A common problem with wall outlets is loose wiring on the connection points of the terminals of the receptacle. A loose wire will also make for a bad connection and cause an unusual amount of heat buildup. Loose connections can also cause sparking in the junction box that can result in arcing. You'll likely see burn marks around the terminals if this happens. You will need to consult with an electrician to replace the wall outlet. You will need to contact Customer Service if the power supply cord is damaged as the power supply will need to be replaced.

## 6. Bluetooth

**Solution:** Please note that you can only have a single device connected to the Bluetooth at any given time. You must unpair your device before connecting with another device. To do a master reset of the Bluetooth, you will need to unplug the sauna power cord from the wall outlet for 15 minutes.

## 7. Speaker Noise

**Solution:** If you are hearing a humming noise from either speaker or both speakers while the Bluetooth feature is connected with your musical device, then there may be an issue with the control panel(s). To confirm this, please connect your musical device using the MP3 AUX wire that came with the sauna room to connect your musical device to the sauna speaker system. You will connect one end of the MP3 AUX wire to your musical device and the other end to the MP3 Jack on the ceiling. If the humming sound can no longer be heard, then this confirms that the control panel(s) will need to be replaced. Please contact Customer Service.

**Solution:** If you hear static noises from the speakers when no music is playing, then be sure that the MP3 AUX wire is not plugged into the ceiling

port. You will have a constant noise coming from the speakers if one end of the MP3 AUX wire is connected to the ceiling port and the other end is not connected to anything.

## 8. Color Lighting

**Solution:** If your color light is not working, the issue with the light may have to do with the connection on the top side of the light fixture. Please go up to the roof panel and disconnect the wire connection on the top side of the light fixture. Then reconnect the wire connection making sure that it is snug and tight. Return back to the sauna control panel to test the light. If the light is still having issues, please contact our Customer Service.

## 9. Dedicated Power Outlet

**Solution:** You have two options when it comes to a dedicated receptacle. You have a true dedicated line if the receptacle is the only receptacle on the line to the breaker in your electric panel box. You have a quasi-dedicated line if you have multiple receptacles on a line to the breaker in your electric panel box and you do not draw any power from the other receptacles when the sauna is in operation. Both of these options are acceptable.

## 10. Lower Heat Emitters

**Solution:** With regards to the lower heat emitters under the bench and on the floor, these heat emitters operate a bit different than the wall heat emitters. As the bench heat emitter and floor heat emitter (200W/125W each) are of much less wattage than the wall heat emitters (300W each), they will not get nearly as hot as the wall heat emitter panels. We can have you run two tests. First, remove the bench from the sauna room. Next, preheat the sauna room by setting the temperature to the maximum of 151 degrees F and time to 90 minutes. Record the starting/beginning temperature and the temperature after 15 minute intervals up to 90 minutes (do not enter the unit or open the door during this test). If the sauna room goes above 130 degrees F (usually after about 40 to 50 minutes of preheating with a beginning temperature above 70 degrees F) at any given time, then we know that the heat emitters are working successfully. With even one heat emitter not working correctly, the sauna room will struggle to get above 130 degrees F within the average allotted time. The next test would be to enter the sauna room and to **cautiously** place your hand on the back side

of the bench heat emitter in the center (this would normally be covered by the bench which you already removed). If you touch the heat emitter panel and it is warm-to-hot, then it is working correctly. If you are able to place your hand on the back side of the heat emitter and it feels like there is no heat being produced, then we know it is not working properly and you will need to contact Customer Service. You can also check the floor heat emitter by touching the heat emitter **cautiously** with your finger. You will need to remove the wood grade cover to get a true feeling of the heat from the floor heat emitter. Please do keep in mind that the bench heat emitter and floor heat emitter only keep the area below the bench warm as heat always rises. The majority of heat is concentrated above the bench. You can use a towel to drape over your legs to trap the heat as it rises if your lower extremities feel a draft.

#### **11. Intentional Rear Wall Warp**

**Solution:** The rear wall panel is intentionally warped as part of the sauna design. This adds strength to the sauna structure once the unit is assembled. Please try the following in assembling the sauna. With one person inside the sauna room and pushing on the rear wall panel outward, a second person should be able to latch the buckles. Make sure that the wall is fitting together like a puzzle as one wall panel fits into the other. Work your way down from top to bottom.

#### **12. Too Much Perspiration On The Floor Heater**

**Solution:** Use 2 towels during your sauna session. Fold the first towel several times and place it on the bench. As you sit on this towel, it will absorb a majority of your perspiration while adding comfort as you sit on the bench. Use the second towel to constantly wipe the perspiration from your body to perspire faster and also to avoid having too much perspiration dripping onto the floor heater. Never place any towels over the floor heater.

## Limited Lifetime Warranty

**5 Year Limited Warranty\*:** Golden Designs, Inc. under the Dynamic brand name warrants the wood, structure, heating elements, and electronics against defects in material and workmanship for a period of 1 to 5 years from the original date of purchase. **This sauna is for INDOOR use only. Placing your sauna outdoors will VOID this warranty. Any damage due to exposure to outdoor elements such as rain, snow, sun, wind or extreme temperatures will not be covered by this warranty. Any damages as a result of modifications made to the sauna or its components will void this warranty.**

**Extent of Warranty:** This limited warranty applies to products manufactured or distributed by Golden Designs, Inc. under the Dynamic brand name, delivered in the continental United States or Canada and extends to the original purchaser at the original site of installation only. This warranty becomes valid at time of purchase and terminates either by specified time frame listed above, owner transfer, or relocation. **Your sales receipt showing the date of purchase of the product is your proof of purchase. Warranty is not transferable.**

### Manufacturer Warranty

All Golden Designs, Inc. products are manufactured with the highest quality appliances and are warranted to be free from defects in material and workmanship at the time of delivery. The appliance warranty is extended through the manufacturer for the product including, but not limited to: stereos, CD/DVD players, etc. All exchanged parts and products replaced under this warranty will become the property of Golden Designs, Inc. Golden Designs, Inc. reserves the right to change manufactures of any part to cover any existing warranty. Any parts determined to be defective must be returned to Golden Designs, Inc. to obtain warranty service. You must prepay any shipping charges, export taxes, custom duties and taxes, or any other charges associated with the transportation of the parts. In addition you are responsible for insuring any parts shipped or returned. You must present Golden Designs, Inc. with proof of purchase documents (including the date of purchase). Any evidence of alteration, erasing or forgery of proof of purchase documents will be cause to **VOID** this limited warranty. Products on which the serial number has been defaced or removed is not eligible for warranty service. This warranty covers parts, but does not cover labor.

### Warranty Limitations

This warranty does not apply if the unit has been subject to negligence, alteration, modification, misuse, abuse, repairs by non-Golden Designs, Inc. authorized personnel, inappropriate installations, or any case beyond the control of Golden Designs, Inc. invalidating this warranty including but are not limited to:

- Use of lacquer or paints
- Sauna and other Golden Designs, Inc. products accessories placed on non-approved surfaces
- Outdoor applications
- Normal wear and tear or weathering
- Use of product not in accordance with instructions
- Worn out receptacle

**Surface cracks are not considered defects in material or workmanship, as they are normal characteristics of all woods. This includes minor cracks due to wood expansion and contraction. Note: Since the wood used in construction has been kiln dried, a certain amount of expansion and contraction occurs in the wood in a sauna environment.**

### **Disclaimers**

Golden Designs, Inc. shall not be liable for loss of use of sauna or other Golden Designs, Inc. products or other secondary or incidental or consequential costs, expense or damages - which may include the removal of permanent deck or other custom fixtures or the necessity for crane removal - arising directly or indirectly out of the use or inability to use the product. Any implied warranty shall have duration equal of the applicable warranty stated above. Under no circumstances shall Golden Designs, Inc. or any of its representatives be held liable for injury to any person or damage to any property, however arising. Specifications are subject to change without notice or obligation.

### **Legal Remedies**

This limited warranty gives you specific legal rights. You may have other rights, which may vary from state to state.

### **Customer Service**

For customer service, contact your authorized dealer. If you need additional information or assistance, please email Golden Designs, Inc. at [info@goldendesignsinc.com](mailto:info@goldendesignsinc.com) or call (909) 212-5555.

\*Limited Lifetime Warranty of Sauna Products is 5 years for residential use and 1 year for commercial use on heating elements and electronics from the date of purchase. The wood structure has a 1 year limited warranty.

## WARRANTY REGISTRATION

Congratulations on your purchase of an Infrared Sauna from Golden Designs, Inc. Please take the time to register your warranty using the QR Code:



If you do not have the QR Code Reader, you can also register at:

<https://app.goldendesigninc.com/public/RegisteredProduct>

Please include a copy of your sales receipt or packing slip when registering. The serial number (S/N) is located on the sauna's front panel, rear panel, or on the carton.

**The warranty must be registered within 60 days of the purchase date.**

