

**Function**

The WMD104 combination water surface agitator is designed to be flush mounted in diving pools to agitate the water surface increasing visibility during diving. These nozzles can accommodate all gutter configurations from parapet to deck level. Interchangeable face plates are provided. The stream jet produce a 1/2" (13mm) column spray (45°) that will strongly agitate the surface of water, while the Crown jet (15°) produces a gentler softer agitation.



**Specification**

Construction shall be machined cast bronze/brass. Face plates shall be removable for nozzle alignment or nozzle cleaning by using a security key. Water inlet connection shall be 1 inch diameter (25mm) (standard 1" n.p.t.).

Requires fine screening at pump, suction strainer openings maximum 0.040" (1mm).

**Options**

Bronze winter cover, order separately by part no. WMF081

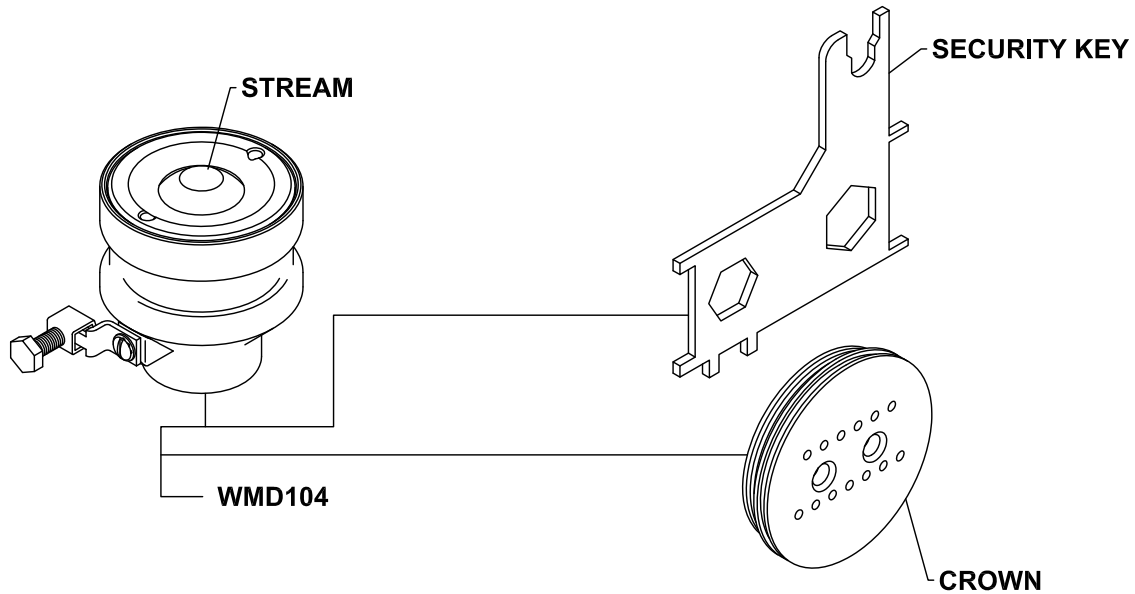

PROPRIETARY AND CONFIDENTIAL

THE INFORMATION CONTAINED IN THIS DRAWING IS THE SOLE PROPERTY OF CRYSTAL FOUNTAINS INC. ANY REPRODUCTION IN PART OR AS A WHOLE WITHOUT THE WRITTEN PERMISSION OF CRYSTAL FOUNTAINS INC. IS PROHIBITED.

CUT SHEET  
WMD104-D101

PAGE  
1 OF 3

www.crystalfountains.com



**WMD104 COMBINATION WATER SURFACE  
AGITATOR FOR DIVING POOLS  
15° / 45°**

SERIES  
WMD

REV.  
E  
JUN 2017

TEL. 1-905.660.6674

FAX. 1-905.660.6916

## Wall Mount Application

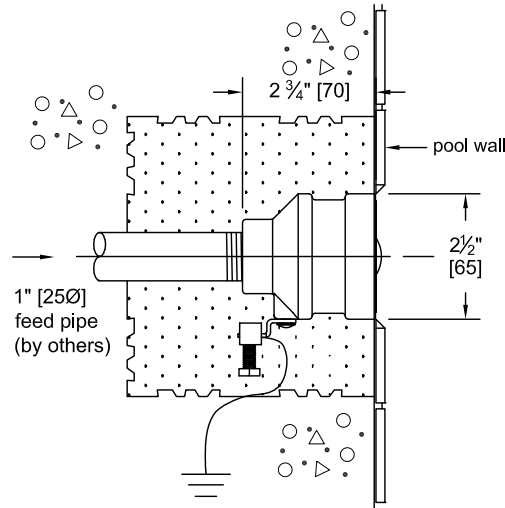

## Stream Effect

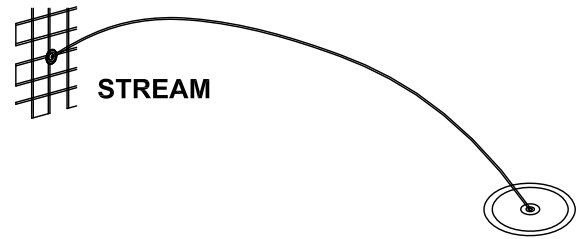
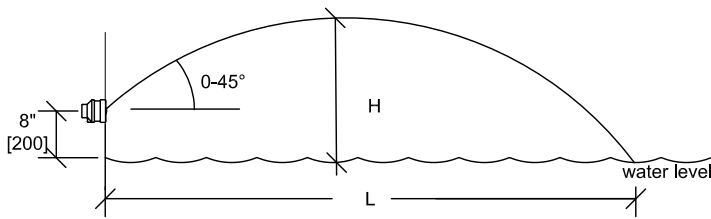

EFFECT	PRESSURE	FLOW	H	L	SPREAD
STREAM	7.2 ft head 2.16 m head	9.5 gpm 36 liter/min	1'2" 0.35M	6'5" 1.92M	2' 0.6M
CROWN	7.8 ft head 2.34 m head	7.3 gpm 27.63 litres/min	6" 0.15M	6'5" 1.92M	5' 1.5M

For interactive play do not exceed 20 ft/sec

## Crown Effect

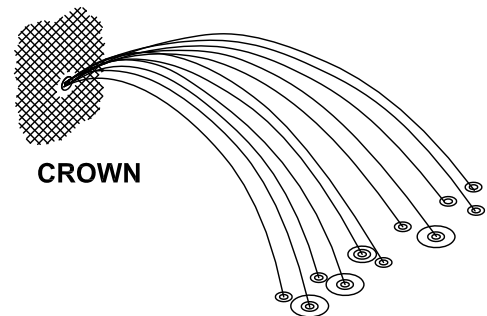
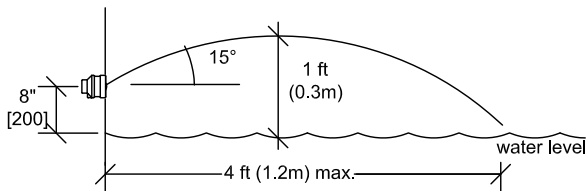

For interactive play do not exceed 20 ft/sec.  
7.5 US gpm @ 7.5 ft of head

ISO  
9001  
QUALITY  
ASSURANCE

PROPRIETARY AND CONFIDENTIAL

THE INFORMATION CONTAINED IN THIS DRAWING IS THE SOLE PROPERTY OF CRYSTAL FOUNTAINS INC. ANY REPRODUCTION IN PART OR AS A WHOLE WITHOUT THE WRITTEN PERMISSION OF CRYSTAL FOUNTAINS INC. IS PROHIBITED.

CUT SHEET  
WMD104-D101

PAGE  
2 OF 3

www.crystalfountains.com  
**Crystal**  
where ideas flow™

**WMD104 COMBINATION WATER SURFACE  
AGITATOR FOR DIVING POOLS**  
15° / 45°

SERIES  
WMD

REV.  
E  
JUN 2017

TEL. 1-905.660.6674

FAX. 1-905.660.6916

## Deck Mount Application

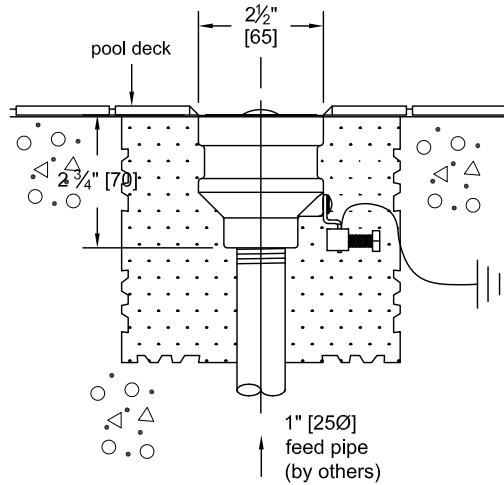

## Stream Effect

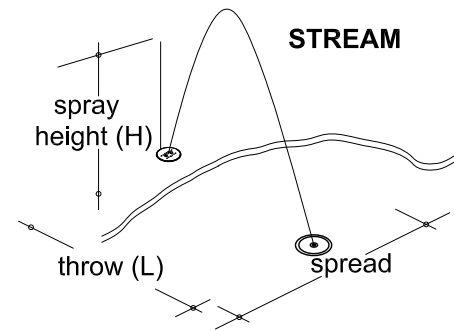
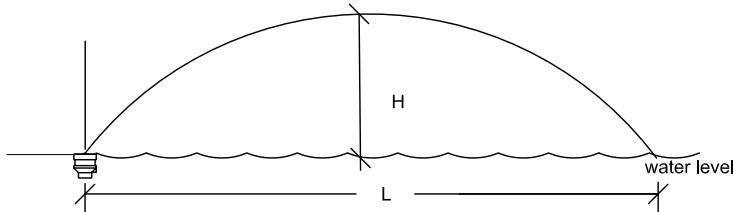

EFFECT	PRESSURE	FLOW	H	L	SPREAD
STREAM	9.2 ft head 2.76m head	9.6 gpm 36.2 liters/min	2'8" 0.8M	6'5" 1.92M	2' 0.6M
CROWN	5.3 ft head 1.59 m head	5.5 gpm 22.1 liters/min	3' 0.9M	3' 0.9M	8' 2.4M

For interactive play do not exceed 20 ft/sec

## Crown Effect

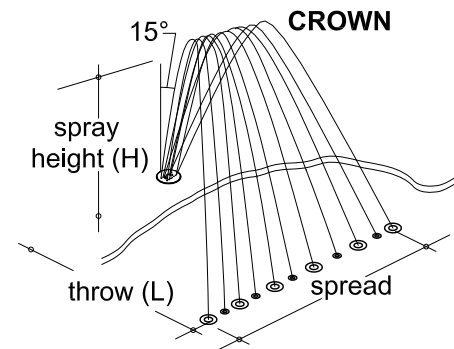
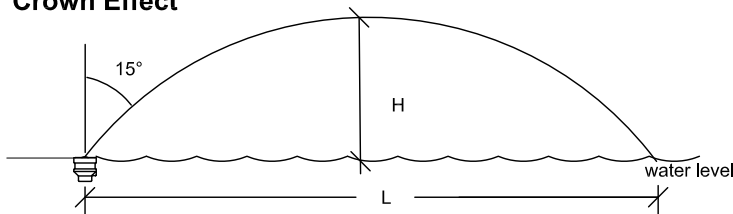

For interactive play do not exceed 20 ft/sec.  
7.5 US gpm @ 7.5 ft of head



PROPRIETARY AND CONFIDENTIAL

THE INFORMATION CONTAINED IN THIS DRAWING IS THE SOLE PROPERTY OF CRYSTAL FOUNTAINS INC. ANY REPRODUCTION IN PART OR AS A WHOLE WITHOUT THE WRITTEN PERMISSION OF CRYSTAL FOUNTAINS INC. IS PROHIBITED.

CUT SHEET  
WMD104-D101

PAGE  
3 OF 3

www.crystalfountains.com  
**Crystal**  
*where ideas flow™*

**WMD104 COMBINATION WATER SURFACE  
AGITATOR FOR DIVING POOLS**  
**15° / 45°**

SERIES  
**WMD**

REV.  
**E**  
JUN 2017