



COMMERCIAL INTELLICHLOR[®] ELECTRONIC CHLORINE GENERATOR MODEL IC60P, CIC60S



INSTALLATION AND USER'S GUIDE

IMPORTANT SAFETY INSTRUCTIONS
READ AND FOLLOW ALL INSTRUCTIONS
SAVE THESE INSTRUCTIONS
KEEP OUT OF REACH OF CHILDREN

Contents

Important Warnings and Safety Instructions	iii - iv
Technical Support	ii
Overview	1
Features	1
IntelliChlor Commercial System Components	2
Acu-Trol panel with ORP sensor (sold separately)	2
PC100 Commercial Power Center - No ORP	2
CPC100 Commercial Power Center with ORP	2
IntelliChlor SCG Control Panel and Cell Description	3
Other System Components	3
IntelliChlor SCG Power Center	3
System Schematic Diagram	4
Install Chlorine/Bromine Feeders after the IntelliChlor SCG cell	4
Loop Plumbing Diagram	5
IntelliChlor Plumbing Diagram	5
Pool Water Preparation	6
Determining Pool Size (Gallons of Water in Your Pool)	6
Determining Pool Size (liters of water in your pool)	6
Section 1: IntelliChlor SCG Control Panel	7
Salt Level Status LEDs	7
Status LEDs	7
Sanitizer Output LED Indicators	8
More and Less Output Buttons	8
Self-Cleaning	8
Section 2: Pool Water and Chemistry, Conditions and Precautions	9
Pool Water Chemistry, Conditions and Precautions	9
Optimum Pool Water Conditions for Salt Water Pools (using the IntelliChlor Salt Chlorine Generator) ...	10
Covered Pools and Vinyl Liner Pool and Lowering Chlorine Output Levels	10
Chlorine Testing	11
What Type of Salt to Use	11
How Much Salt to Use?	11
Calculating the Saturation Index	12
TDS Factor	12
Langelier Saturation Index Factors	12
How to Add Salt to the Pool	13
Table 2. Approximate amount of stabilizer (cyanuric acid) to obtain 40 ppm in pool	13
Table 1. Approximate Pounds (Kg) of salt needed to obtain 3,400 ppm in pool	14
Section 3: Operating IntelliChlor	15
Initial Start up Period	15
Operation	15
Use of an external Pool Pump Timer is not required	15
If you use a Pool Pump Timer	15
Startup Procedure (Super Chlorination)	16
Sanitizer Output Settings and Adjustments	16
Operating in Winter	16
General Recommendations	17
General Cautions	17

Contents (Continued)

Section 4: User Maintenance	18
Daily service	18
Weekly service	18
Monthly Service	18
Usage Hours Meter	19
Cleaning the IECG Cell Blades	19
Winterizing	20
Section 5: Installation	21
Kit Contents	21
Required Tools	21
IntelliChlor “Dummy” Cell	22
Installing the IntelliChlor Cell Assembly	22
Connecting the Cell Power Cable to the Power Center	23
Section 6: Troubleshooting	24
Table 1: Troubleshooting	24
System Specifications - 110 VAC and 220 VAC Wiring	26
220 VAC Basic System Wiring	26
110 VAC Basic System Wiring	26

Technical Support

8 A.M. to 7:30 PM

Phone: (800) 831-7133

Fax: (800) 284-4151

Visit: www.pentair.com

Recommended Pool Sizing Chart for Commercial Applications

The following chart represents recommended commercial IntelliChlor systems for given pool sizes. A commercial system requires an external ORP panel and sensor to produce chlorine upon demand as needed and is sold separately (The Acu-Trol AK110 pH/ORP system is recommended). Commercial systems (COMSYS) can be expanded to support larger pool sizes, for example a 150,000 gallon pool would use a COMSYS 16 and seven additional secondary cells and additional manifolds.

System Description	Number of Power Centers	Number of Cells	lbs. of Chlorine produced in 24 Hrs. (2 lbs. per cell)	Pool Size (Gallons of Water) (1 cell = 10,000 gallons.)
COMSYS-4	2: 1 Primary 1 Secondary	2 cells: 1 CIC60P 1 CIC60S	4 lbs.	20, 000
COMSYS-6	3: 1 Primary 2 Secondary	3 cells: 1 CIC60P 2 CIC60S	6 lbs.	30, 000
COMSYS-8	4: 1 Primary 3 Secondary	4 cells: 1 CIC60P 3 CIC60S	8 lbs.	40, 000
COMSYS-10	5: 1 Primary 4 Secondary	5 cells: 1 CIC60P 4 CIC60S	10 lbs.	50, 000
COMSYS-12	6: 1 Primary 5 Secondary	6 cells: 1 CIC60P 5 CIC60S	12 lbs.	60, 000
COMSYS-14	7: 1 Primary 6 Secondary	7 cells: 1 CIC60P 6 CIC60S	14 lbs.	70, 000
COMSYS-16	8: 1 Primary 7 Secondary	8 cells: 1 CIC60P 7 CIC60S	16 lbs.	80, 000

IMPORTANT WARNINGS AND SAFETY INSTRUCTIONS

SAVE THESE INSTRUCTIONS



Important Notice: Attention Installer: This manual contains important information about the installation, operation and safe use of this product. This information should be given to the owner and/or operator of this equipment. When installing and using this electrical equipment, basic safety precautions should always be followed, including the following:



⚠ WARNING: IMPORTANT SAFETY INSTRUCTIONS PERTAINING TO A RISK OF FIRE, ELECTRIC SHOCK, OR INJURY TO PERSONS. READ AND FOLLOW ALL INSTRUCTIONS.

Before installing this product, read and follow all warning notices and instructions which are included. Failure to follow safety warnings and instructions can result in severe injury, death, or property damage. Call (800) 831-7133 for additional free copies of these instructions, or obtain a copy of these instructions at <http://www.pentair.com>.



WARNING: To reduce the risk of injury, do not permit children to use this product.



WARNING: CHLORINE GAS BUILDUP CAN OCCUR WITH IMPROPER WIRING: To reduce the risk of personal injury the IntelliChlor® Salt Chlorine (SCG) Power Center must be installed on and wired to the load side of the time clock, electronically controlled switch, or relay load side, so that it will receive power only when the pool pump is on. Otherwise, dangerous chlorine gas buildup can occur. The IECG should never be energized when the pool pump is OFF and water is not flowing through the unit.



WARNING: To reduce the risk of injury, service should only be performed by a qualified pool service professional.



WARNING: Never operate the IntelliChlor Salt Chlorine (SCG) without proper flow or water circulation. A build-up of flammable gases will result in hazardous conditions.



CAUTION - IntelliChlor Salt Chlorine (SCG) is for use with permanently-installed pools and may also be used with hot tubs and spas if so marked. Do not use with storable pools. A permanently-installed pool is constructed in or on the ground or in a building such that it cannot be readily disassembled for storage. A storable pool is constructed so that it is capable of being readily disassembled for storage and reassembled to its original integrity.







WARNING: When mixing acid with water, **ALWAYS ADD ACID TO WATER. NEVER ADD WATER TO ACID.**

Replacement CIC60P and CIC60S Cell Part Numbers

- CIC60P - P/N 521151
- CIC60S - P/N 521005

IMPORTANT WARNINGS AND SAFETY INSTRUCTIONS

SAVE THESE INSTRUCTIONS

-  **CAUTION** - Use of chemicals other than those recommended may be hazardous. Even proper use of the recommended chemicals can be hazardous. Follow the Chemical Manufacturer's Instructions.
-  **CAUTION** - To reduce the risk of electric shock, install IntelliChlor Electronic Chlorine Generator (IECG) a minimum of five (5) feet away from the inside wall of the pool.
-  **CAUTION** - Install the IECG a minimum of three (3) feet away from the heater outlet.
-  **CAUTION** - It is recommended to install a Pentair **two (2) inch CHECK VALVE** (P/N 263042) between the input side of the IECG and the main heater output pipe.
-  **CAUTION** - A solid copper, bonding conductor not smaller than No. 8 AWG (8.4 mm) should be connected from the accessible wire connector on the unit to all metal parts of the swimming pool, spa, or hot tub structure and to all electrical equipment, metal conduit, and metal piping within five (5) feet (1.5 m) of the inside walls of a swimming pool, spa, or hot tub, when the unit is installed within five (5) feet of the inside walls of the swimming pool, spa, or hot tub.

Canada - Industry Canada (IC) - This device complies with RSS210 of Industry Canada. (1999)

FCC Standard - 47 CFR Part 15, Subpart C (Section 15.247). This version is limited to chapter 1 to chapter 11 by specified firmware controlled in the U.S.A.

Federal Communications Commission (FCC) - This device complies with Part 15 of the FCC Rules. Operation is subject to the following two conditions: (1) this device may not cause interference, and (2) this device must accept any interference, including interference that may cause undesired operation of the device.

Interference Statement - This equipment has been tested and found to comply with the limits for a Class B digital device, pursuant to Part 15 of the FCC Rules. These limits are designed to provide reasonable protection against harmful interference in a residential installation. This equipment generates, uses and can radiate radio frequency energy and, if not installed and used in accordance with the instructions, may cause harmful interference to radio communications. However, there is no guarantee that interference will not occur in a particular installation. If this equipment does cause harmful interference to radio or television reception, which can be determined by turning the equipment off and on, the user is encouraged to try to correct the interference by one or more of the following measures:

- Reorient or relocate the receiving antenna.
- Increase the separation between the equipment and receiver.
- Connect the equipment into an outlet on a circuit different from that to which the receiver is connected.
- Consult the dealer or an experienced radio/TV technician for help.

Note: Modifications not expressly approved by the party responsible for FCC compliance could void the user's authority to operate the device.

IntelliChlor® Salt Chlorine Generator (SCG) Overview

The IntelliChlor Salt Chlorine Generator (SCG) uses a process known as electrolysis to produce chlorine gas which immediately dissolves into a solution to create Hypochlorite and Hypochlorous acid pool and spa water sanitizer from a low concentration of salt added to the pool water. Hypochlorite and Hypochlorous kill bacteria, oxidizes organic material, and kills algae, then reverts back to salt. The IntelliChlor SCG then reuses the salt and the process starts over again. The IntelliChlor SCG residential system is comprised of the IntelliChlor SCG cell and Power Center.

CAUTION

The IntelliChlor SCG is designed only to produce chlorine. The IntelliChlor SCG does not monitor or control chlorine levels in the pool or spa water. It is the pool owner's responsibility for monitoring and maintaining free chlorine levels at the APSP recommended range of 2.0 to 4.0 parts per million (ppm). It is the pool owner's responsibility to check, on a regular basis, the free chlorine level while the pool pump is running, and adjust the IntelliChlor SCG accordingly.

WARNING

Salt is an inherently corrosive material. While the levels of salt required for proper operation of the IntelliChlor SCG are relatively low when compared to sea water and other salt solutions, placing any amount of salt in your pool increases the likelihood of corrosion or other deterioration of pool equipment and any surfaces used in and around your pool. Metal parts (including steel pools) and certain natural and man-made surfaces are particularly susceptible to corrosion and deterioration when used in and around salt water pools. Pentair Water Pool and Spa, Inc. ("Pentair") does not represent or otherwise guarantee that the proper use of the IntelliChlor SCG will prevent corrosion or other deterioration of pool equipment and any surfaces used in and around your pool. Consult your experienced pool professional, who should be able to advise you on the proper material selection, installation techniques for those materials, and the proper use, care and maintenance of those materials for your specific pool type and location in order to minimize the corrosion and deterioration that is inherent in and around salt water pools.

CAUTION

FOR ALL NEWLY CONSTRUCTED OR RESURFACED PLASTER POOLS: Do not operate the IntelliChlor SCG with newly poured or resurfaced pool plaster. Salt is a corrosive element and severe salt damage can occur to your pool. Wait at least ONE (1) MONTH after construction to allow plaster to cure before adding salt and operating IntelliChlor SCG. Follow the pool surface manufacturer's guidelines for your specific pool. FOR NEW VINYL LINER POOLS, contact the manufacturer for recommended guidelines before adding salt and operating the IntelliChlor SCG.

Replacement CIC60P and CIC60S Cell Part Numbers

- CIC60P - P/N 521151
- CIC60S - P/N 521005

IntelliChlor Commercial System Components

An IntelliChlor Commercial System components can be configured as follows:

- **Stand-alone - No ORP:** This system consists of one CIC60P cell, one PC100 power center, and no oxidation reduction potential (ORP) sensor/panel. Chlorine is dispensed on a timed basis, set by the MORE and LESS buttons on the cell.
- **Stand-alone with ORP:** This system consists of one CIC60P cell, one CPC100 power center, and an oxidation reduction potential (ORP) sensor/panel system (sold separately). The chlorine is dispensed on demand from the ORP sensor.
- **Multi-Cell with ORP:** This system consists of one CIC60P cell and multiple secondary cells, CIC60S, multiple power centers, and an oxidation reduction potential (ORP) sensor/panel system (sold separately). The chlorine is dispensed on demand from the ORP sensor. For multiple cell systems, there is one CIC60P cell, labeled PRIMARY and additional CIC60S cells labeled SECONDARY. The SECONDARY cells communicate with the PRIMARY cell. Note: There can only be one PRIMARY cell in a multiple cell system.

Acu-Trol panel with ORP sensor (sold separately)

The Acu-Trol panel contains an oxidation reduction potential (ORP) sensor that is placed in the water stream to detect the amount of sanitizing ability in the water and according to a user-preset trip point, calls for chlorine when low, and cancels chlorine when satisfied. This panel provides a dry-contact output that connects to the IntelliChlor system. When the dry-contact terminals are closed, chlorine is required. When the dry contact terminals are open, no chlorine is required. The Acu-Trol panel is not used for a stand-alone-No ORP system.

PC100 Commercial Power Center - No ORP

The PC100 commercial power center provides power to one CIC60P cell, but does not interconnect to an ORP system. The CIC60P cell will operate on a timed basis, set by the MORE and LESS buttons on the cell. This system may be used with a time clock to control operations.

CPC100 Commercial Power Center with ORP

The CPC100 commercial power center, with ORP provides power to each cell. The power center labeled PRIMARY contains the dry-contact wires that connect to the external ORP system. When the dry-contact wires are closed, the "Primary" panel sends a 100% command to the cell; chlorine is being produced. When the dry-contact wires are opened, the Primary panel sends a 0% output command to the cell, to stop producing chlorine.

Example 1:

Small hotel pool requires a two (2) lb. system.

Equipment used: One CIC60P cell
 One CPC100 power center (one power center)
 Acu-Trol panel with ORP sensor

Example 2:

Health club spa requires a four (4) lb. system

Equipment used: Use multiple-cell system COMSYS-4

Sizing:

To correctly size the chlorine requirements of a commercial pool, use the following rule:

- Two (2) lbs. of chlorine per 10,000 gallons of water

To size a commercial spa, use this general rule:

- One pound of chlorine per 2,000 gallons of water

These rules appear oversized, but ensure rapid chlorine make-up time, essential for commercial health codes.

IntelliChlor SCG Control Panel and Cell Description

The IntelliChlor SCG includes a control panel with buttons and LED indicators to control the IntelliChlor SCG and produce chlorine (see page 7). The IntelliChlor SCG measures the water temperature and salt level to produce chlorine at the defined output. If the salt level in the pool water is too low (red on salt display), the cell is turned off until salt is added to the pool. The SCG cell has a self-cleaning cycle which reverses the cell polarity, reducing calcium buildup. This feature turns the cell on and off at regular intervals to minimize calcium and scale buildup and further maximizes cell life (see page 15).

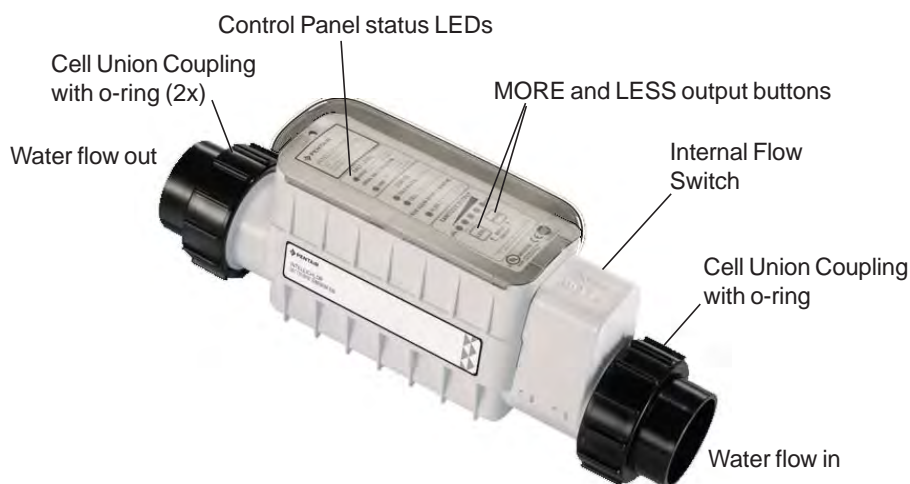

IntelliChlor® Salt Chlorine Generator (SCG) Cell

System Components

The chlorine production can be varied by either adjusting the sanitizer output level on the control panel and/or by varying the number of hours the IntelliChlor SCG is on each day. *The IntelliChlor SCG automatically reverses the cell electrode blades every few hours to help clean the cell. This process does not interrupt the production of Chlorine.*

- **Flow Sensor:** A flow sensor assures that there will always be adequate water flow through the IntelliChlor SCG. If the IntelliChlor SCG is not properly plumbed and/or does not receive adequate water flow, no chlorine will be produced.
- **Temperature Sensor:** To protect the IntelliChlor SCG from operation and potential damage when the temperature of the pool water falls below 52° F, ±3° F (11° C, ±1.67° C), the temperature sensor switches the IntelliChlor SCG off, illuminates the COLD WATER light and no chlorine will be produced.
- **Salt Sensor:** Two (2) salt sensor probes in the IntelliChlor SCG are activated each time the IntelliChlor SCG is switched on and again during every 12 hours of operation. At each of those times, the salt level LED indicator lights flash in a scrolling sequence for two (2) minutes to indicate that the IntelliChlor SCG is in analysis mode. After two (2) minutes, the LED indicators lights will signal one (1) of three (3) salinity ranges. For more information, see “Salt Level Status LEDs” on page 7.

Note: The salt sensor reading is within +/- 500 ppm accuracy.

IntelliChlor® SCG Power Center (CIC60P, CIC60S)

The IntelliChlor Power Center converts AC electrical current to a low-voltage DC electrical current which is required to produce chlorine. The power supply is connected with the pool circulation pump electrical source so that the IntelliChlor SCG only operates when the pool pump is on. The Power Center should be mounted vertically on the wall up to fifteen (15) feet away from the IntelliChlor SCG. The Power Center contains the transformer, fuse, connector to the cell and the AC electrical current wiring configuration with the DC electrical current output cable to the IntelliChlor SCG. A fuse holder is mounted on the bottom of the Power Center for additional protection. There are no other controls or lights on the Power Center. For information about installing and proper use of the Power Center, see the “IntelliChlor Power Center Installation Guide,” (P/N 520590).



IntelliChlor® Power Center (Model PC 100 and CPC 100)



WARNING: CHLORINE GAS BUILDUP CAN OCCUR WITH IMPROPER WIRING: To reduce the risk of personal injury the IntelliChlor SCG Power Center must be installed on and wired to the load side of the time clock, electronically controlled switch, or relay load side, so that it will receive power only when the pool pump is on. Otherwise, dangerous chlorine gas buildup can occur. The IntelliChlor SCG should never be energized when the pool pump is OFF and water is not flowing through the unit.



CAUTION - Before plugging or unplugging the IntelliChlor SCG to the Power Center, first switch off the AC power to the Power Center.

System Schematic Diagram

The following schematic diagram shows a typical IntelliChlor® SCG system installation.

Note: Refer to the relevant portions of this Installation and User's Guide for information regarding proper placement and spacing of all equipment depicted in the schematic diagram shown below. The schematic diagram is not drawn to scale. .

Install Chlorine/Bromine Feeders after the IntelliChlor® SCG Cell

⚠ CAUTION - To avoid permanent damage to the IntelliChlor SCG cell, in-line chlorine/bromine feeders (such as Pentair Water Pool and Spa Rainbow® models) **MUST** be installed **AFTER** the IntelliChlor SCG cell as shown below. When using the IntelliChlor SCG with an in-floor cleaning system, it is recommended that a separate return line be used for the cleaner to reduce the increased water pressure stress on the IntelliChlor cell.

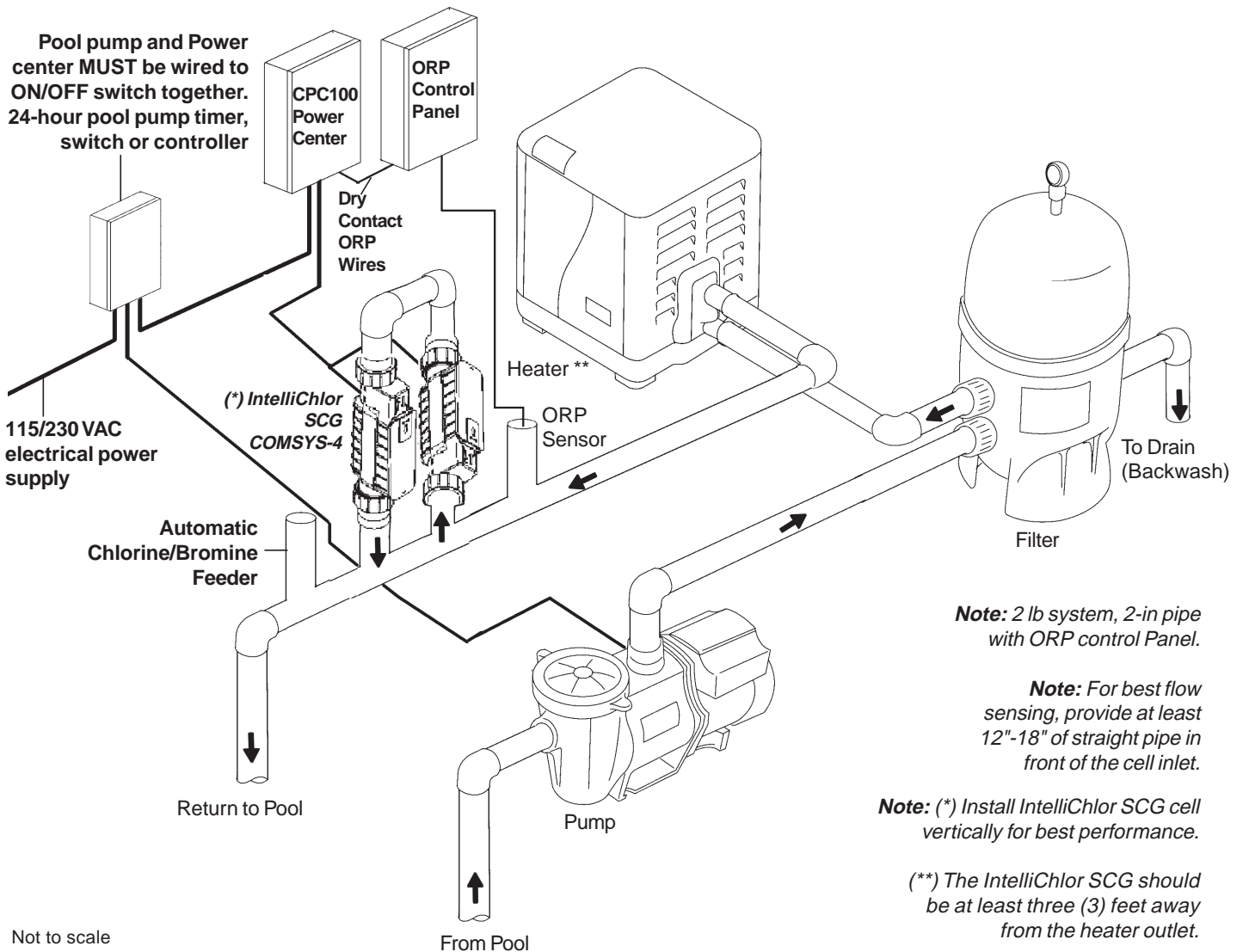

IntelliChlor SCG System Schematic Diagram

Loop Plumbing Diagram

The IntelliChlor® SCG is designed to operate with water flow rates from 20 to 30 gallons per minute (gpm) up to 105 gpm with a maximum pressure of 75 psi. Refer to the pipe manufacturer specifications for recommended maximum flow rate. For flow rates over 80 gpm you must use a bypass loop (as shown below) for best chlorine production. Installations with flow rates over 80 gpm include those that have in-floor cleaning systems or booster pumps. These systems MUST use a bypass loop with the IntelliChlor SCG with a flow control valve that assures that the flow through the IntelliChlor SCG is maintained within its designed operating water flow rates.

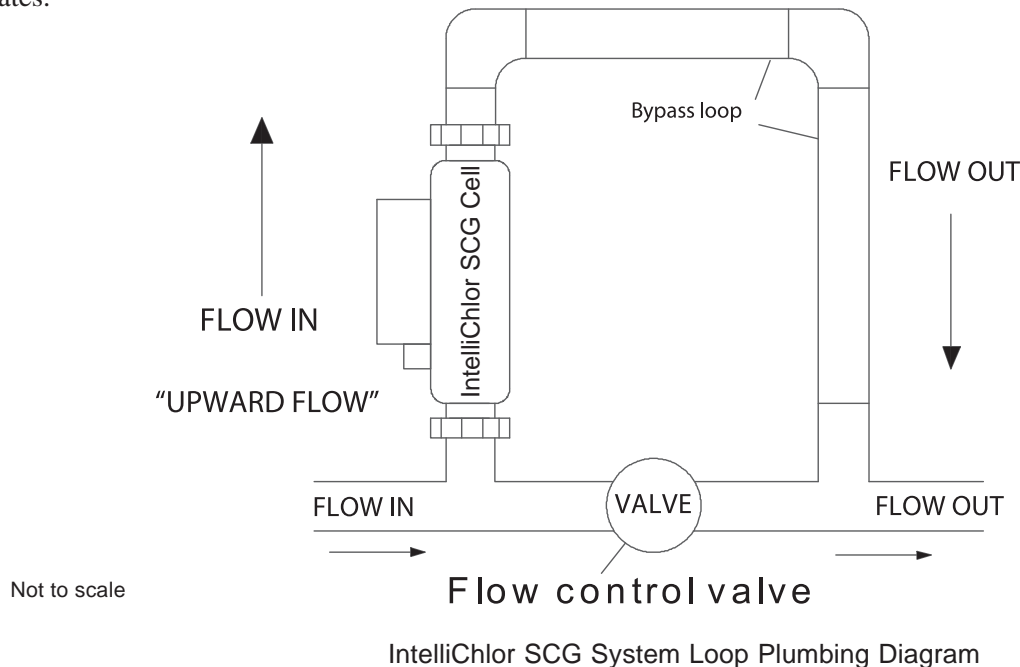

IntelliChlor SCG Plumbing Diagram

Plumbing the IntelliChlor® Salt Chlorine Generator:

- Always install the IntelliChlor SCG AFTER the filter and heater (see “System Schematic Diagram” on page 4). The IntelliChlor SCG should be at least three (3) feet away from the heater outlet.
- If the IntelliChlor SCG is installed on a pool/spa combination system, install (see diagram below) the IntelliChlor SCG BEFORE the pool/spa return valve to allow proper chlorination of both the pool and spa and also to avoid creating gas being trapped in the pool plumbing.

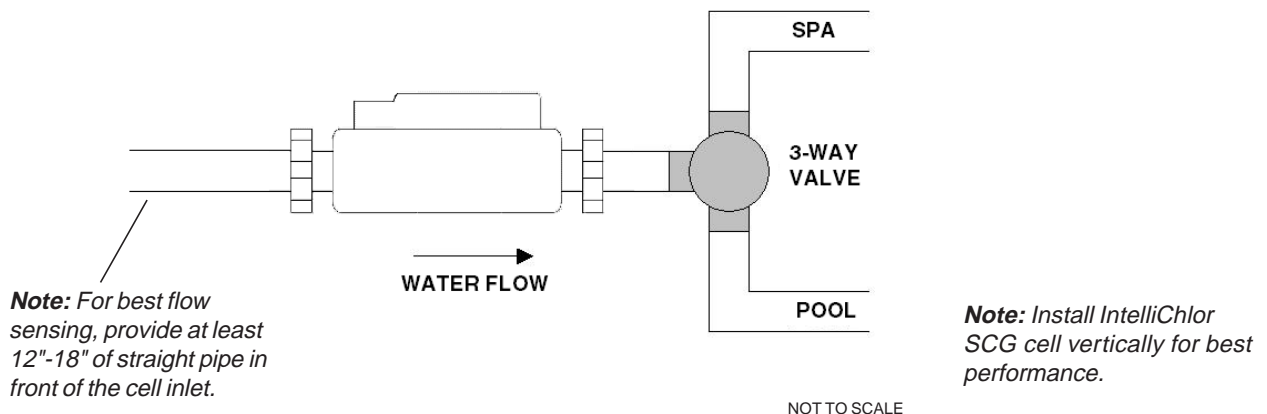

Pool Water Preparation

Determining Pool Size (Gallons of Water in Your Pool)

- **Rectangular Pools:** Length x width x average depth x 7.5
- **Circular Pools:** Diameter x diameter x average depth x 5.9
- **Oval Pools:** Length x width x average depth x 6.7
- **Sloping Sides:** Multiply total gallons by 0.85 = gallon capacity

Determining Pool Size (liters of water in your pool)

- **Rectangular Pools:** Length x width (meters) x average depth x 1000
- **Circular Pools:** Diameter x diameter x average depth x 785
- **Oval Pools:** Length x width (meters) x average depth x 893
- **Sloping Sides:** Multiply total liters by 0.85 = liter capacity.

 **CAUTION - Never use dry acid (sodium bisulfate) to adjust pH in arid geographic areas with excessive evaporation and minimal dilution of pool water with fresh water. A buildup of byproducts can damage the IntelliChlor® SCG.**

Section 1

IntelliChlor® SCG Control Panel

Salt Level Status LEDs

The IntelliChlor SCG checks the pool salinity water daily and displays the levels as follows:

- 1 Green LED: Good salt.** The pool water salt level is between 3300 ppm and 5000.

Green LED (Flashing): Salt level is above 5000 ppm. The salt level is high which increases the risk of corrosion and deterioration of pool equipment and surfaces in and around the pool.

- 2 Red LED: Low salt.** The water salt level is below 3300 ppm. The IntelliChlor SCG will be producing chlorine at reduced efficiency. It is highly recommended to add salt. See (*) Note below.

Red LED: Very low salt. The water salt level has fallen below 2600 ppm. The IntelliChlor SCG will not produce chlorine until salt is added. The IntelliChlor SCG is OFF. See (*) Note below.

NOTE (*): After every salt addition, pump should be allowed to run for at least 24 hours for proper dilution. Salinity readings should only be taken, after the dilution period.

Status LEDs

- 3 Cold Water:** Shows the IntelliChlor SCG power status:

- **No Light:** The IntelliChlor SCG is operating in the normal temperature range (> 52° F (11° C))
- **Red:** The IntelliChlor SCG is in "Standby" mode (system off, no chlorine production) due to a cold water condition. The IntelliChlor SCG will resume to normal operation mode, including accurate salinity report, once water temperature goes above 52° F (11° C).

- 4 Cell:** Shows the status of the IntelliChlor SCG.

- **Green (flashing):** The IntelliChlor SCG needs to be inspected. The blades may have calcium buildup. The IntelliChlor SCG is not producing chlorine.
 - **Green:** IntelliChlor SCG is good and producing chlorine
- No Light:** IntelliChlor SCG is off and not producing chlorine. It may be in an off-period of the sanitizing cycle and will return on shortly.

- 5 Flow:** This light indicates the status of water flowing through the IntelliChlor SCG.

- **Red:** Insufficient water flow through the IntelliChlor SCG, no chlorine is being produced.
- **Green:** Sufficient water flow to produce chlorine.

- 6 Sanitizer Output LED indicators:** See page 8.

- 7 Less / More Buttons:** Controls the percentage of the total output capacity that the IntelliChlor SCG is producing while the pump is on (see Sanitizer Output LED indicators above). See page 8.

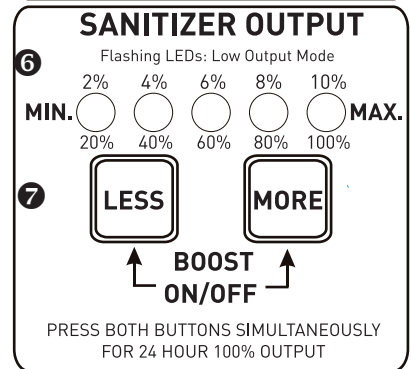
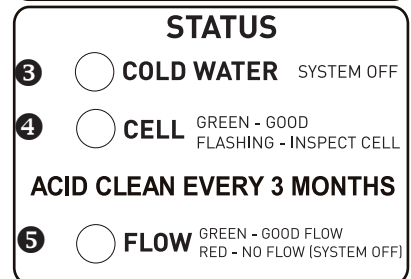
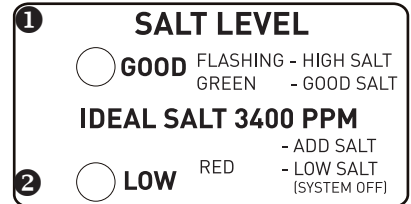

Operator Control Panel (continued)

Sanitizer Output LED Indicators

The five (5) LED indicators display as a bar graph to show the cell output in either 2% or 20% increments, the percentage of the total output capacity of chlorine being produced. Percentages from 2% to 10% are represented by blinking LEDs. Percentages from 20% to 100% are represented by solid LEDs. In BOOST mode, these LEDs scroll from left to right.

0%	No LEDs lit - No chlorine produced - IntelliChlor SCG is off.
2%	1 LED blinking Produces chlorine for 64 seconds of every hour.
4%	2 LEDs blinking Produces chlorine for 127 seconds of every hour.
6%	3 LEDs blinking Produces chlorine for 16 seconds of each 5 minute period.
8%	4 LEDs blinking Produces chlorine for 21 seconds of each 5 minute period.
10%	5 LEDs blinking Produces chlorine for 27 seconds of each 5 minute period.
20%	1 LED solid Produces chlorine for 53 seconds of each 5 minute period.
40%	2 LEDs solid Produces chlorine for 106 seconds of each 5 minute period.
60%	3 LEDs solid Produces chlorine for 159 seconds of each 5 minute period.
80%	4 LEDs solid Produces chlorine for 212 seconds of each 5 minute period.
100%	5 LEDs solid Produces chlorine for 265 seconds of each 5 minute period.

More and Less Output Buttons

The More and Less buttons control the percentage of the total output capacity that the IntelliChlor SCG is producing while the pump is on (see Sanitizer Output LED indicators above). The lights act as a bar graph: the more lights that are on, the more chlorine is produced. Blinking LEDs represent 2%, 4%, 6%, 8% & 10% while solid LEDs represent 20%, 40%, 60%, 80% and 100%. Slide the panel cover up to access the More, Less and Boost On/Off buttons. *Note: When an IntelliChlor is connected to an IntelliTouch®, EasyTouch® or SunTouch® Control System, the Less and More buttons are disabled and IntelliChlor SCG Sanitizer Output is controlled externally.*

More: Increases the output of the cell in 2% increments up to 10% and then 20% increments. Example: The Sanitizer Output display is showing 8%. Pressing the MORE button once will blink the 10% light. The unit will produce chlorine at 10% of total capacity. Pressing MORE again will turn on the 20% light, and so on until all five (5) lights are on solid.

Less: Decreases the time the cell produces chlorine, in either 2% or 20% increments (from 20% to 100%). Example: The Sanitizer Output display is showing 40%. Pressing the LESS button once will turn off the 40% light, leaving only the 20% light. The unit will produce 20% of total capacity of the cell. Pressing LESS again will turn go to 10% (all 5 LEDs blinking).

Boost On/Off: Press and hold both the More and Less buttons together to turn Boost mode on or off. Boost mode sets the sanitizer output to run 100% for the next 24 hours of pool pump run time. If the time clock switches off the pump cycle, then switches power back on the next day, Boost mode will continue until 24 hours has elapsed since Boost mode was turned on or Boost mode is canceled by the user. The Sanitizer Output display will scroll the output LEDs to indicate Boost mode.

Self-Cleaning

The self-cleaning feature reduces scale buildup on the blades of the IntelliChlor SCG. The self-cleaning cycle tends to reduce the life of the IntelliChlor SCG, therefore, it should be used only to the extent necessary to minimize the scale buildup on the blades. It is factory set to two (2) hours for the first 30 days of operation, then automatically switches to three (3) hours.

Section 2

Pool Water Chemistry, Conditions and Precautions

This section describes the start up procedure and operating instructions for IntelliChlor® SCG.

▲ CAUTION: The use of dry acid (sodium bisulfate) to adjust pool pH is discouraged especially in arid regions where pool water is subject to excessive evaporation and is not commonly diluted with fresh water. Dry acid can cause a buildup of by-products that can damage your chlorinator cell.

Pool Water Chemistry, Conditions and Precautions

1. **New Pool Water:** A recently filled or newly-refinished pool may contain undesirable matter. This undesirable matter could interfere with the IntelliChlor SCG's ability to chlorinate properly. Make sure the water is tested by a pool professional and properly balanced before switching on the IntelliChlor SCG.

▲ WARNING

Salt is an inherently corrosive material. While the levels of salt required for proper operation of the IntelliChlor SCG are relatively low when compared to sea water and other salt solutions, placing any amount of salt in your pool increases the likelihood of corrosion or other deterioration of pool equipment and any surfaces used in and around your pool. Metal parts (including steel pools) and certain natural and man-made surfaces are particularly susceptible to corrosion and deterioration when used in and around salt water pools. Pentair Water Pool and Spa ("Pentair") does not represent or otherwise guarantee that the proper use of the IntelliChlor SCG will prevent corrosion or other deterioration of pool equipment and any surfaces used in and around your pool. Consult your experienced pool professional, who should be able to advise you on the proper material selection, installation techniques for those materials, and the proper use, care and maintenance of those materials for your specific pool type and location in order to minimize the corrosion and deterioration that is inherent in and around salt water pools.

2. **Super Chlorination** burns out the swimmer waste that has combined with chlorine. This frees the chlorine for sanitizing. This is accomplished by raising the chlorine level quickly and dramatically. When the chlorine level is raised to ten (10) times the amount of combined chlorine the pool water is said to have been super chlorinated. As pool water is continuously passed through the IntelliChlor SCG while the unit is powered on, the water inside the IntelliChlor SCG is being super chlorinated. *Note: On initial start-up of a pool, it is best to super chlorinate using an outside source, i.e., use a shock treatment available at your local pool supplier.*
3. **Chloramines** should not be present in pool water. Chloramines are formed when ammonia (which is found in urine and sweat) combine with free chlorine. This ties up the free chlorine in your pool and does not allow the chlorine in your pool to disinfect. Chloramines also burn the eyes and are foul smelling. Super Chlorinate to remove chloramines at the initial start-up of the pool and as needed to maintain proper levels of free chlorine.
4. **Cyanuric acid** is needed in outdoor pools to help to stabilize and maintain proper levels of chlorine. 90% of unstabilized chlorine is destroyed by the UV radiation from the sun within two hours. Cyanuric acid stabilizes chlorine in water from UV degradation. When using the IntelliChlor SCG, the cyanuric acid level should be maintained between 30-50 ppm. See Table 2, on page 13. **NOTE: DO NOT USE CYANURIC ACID IN INDOOR POOLS.**
5. **Total Dissolved Solids (TDS):** Adding salt to pool water will raise the TDS level. While this does not adversely affect the pool water chemistry or clarity, the pool water professional testing for TDS must be made aware salt has been added to the IntelliChlor SCG system. The individual performing the TDS test (see page 19) may then subtract the salinity level to arrive at a TDS level that would be compatible to a TDS reading for a non-salt water pool.

Continue on next page.

Pool Water Chemistry, Conditions and Precautions (Continued)

6. **Metals** - Some metals, i.e. copper and iron, can cause loss of chlorine. Also, metals can stain your pool. Metals can also damage the IntelliChlor® SCG. Have your local pool professional check for metals and recommend methods of removal.
7. **Nitrates and Phosphates** can cause extremely high chlorine demands and will deplete chlorine from your swimming pool. In some cases nitrates may even lower your chlorine levels to zero. Your local pool professional can test for nitrates and phosphates. While a 0 ppm level of nitrates is the ideal, the pool owner should make sure that nitrates **DO NOT** exceed 10 ppm. Phosphates should not exceed 125 parts per billion (ppb).

Optimum Pool Water Chemistry Conditions for Salt Water Pools

(using the IntelliChlor SCG)

In accordance with the Association of Pool and Spa Professionals (APSP) standards, it is recommended that the following pool water chemistry conditions be maintained on an on going basis to help protect pool users, pool related equipment and surfaces in and around the pool. These values are important to maintaining the pool equipment in proper operating condition and preventing corrosion. For more information, refer to your local agency having jurisdiction, NSPI (National Spa and Pool Institute), the CDC (Centers for Disease Control), or the WHO (World Health Organization).

Free Chlorine:	2.0 - 4.0 ppm. Above 4.0 ppm may cause corrosion of metal components
Combined Chlorine (Chloramines):	None (super chlorinate to remove all chloramines)
pH:	7.2 - 7.8 (USE MURIATIC ACID to lower pH and Soda Ash to raise pH.)
Cyanuric Acid:	30 - 50 ppm
Total Alkalinity:	80 - 120 ppm
Calcium Hardness:	200 - 400 ppm
TDS (includes salt):	3000 minimum to 5700 to 6000 maximum ppm
Salt:	3600 - 4500 ppm (ideal 3600 ppm)
Metals (Copper, Iron, Manganese):	None
Nitrates:	None
Phosphates:	Less than 125 ppb
Saturation Index	-.3 to .3 (zero (0) best)

Covered Pools and Vinyl Liner Pool and Lowering Chlorine Output Levels

When using the IntelliChlor SCG with covered pools and/or vinyl liner pools, less chlorine is needed. It is recommend to lower the chlorine output level while the pool is covered. For more information about chlorine output levels, see “More or Less Output Buttons” page 8.

Chlorine Testing

It is recommended that chlorine test samples be taken from two (2) locations in the pool. Compare the samples. A higher level should be found at the pool return line. The higher level at the pool return line indicates the IntelliChlor® SCG is producing chlorine. Take chlorine samples for testing at:

- The pool return line.
- 18 inches (457 mm) below the surface and well away from the pool return line.

What Type of Salt to Use

Use salt that is at least 99.8% pure NaCl, sodium chloride. The preferred and recommended salt is an evaporated, granulated, food quality, non-iodized salt with no additives. Consult your salt supplier.

- Avoid using salt with anti-caking agents (sodium ferrocyanide, also known as YPS or yellow prussiate of soda). Filling agents can cause some discoloration of fittings and surface finishes in pool.
- Water conditioning salt pellets are compressed forms of evaporated salt and may be used, but will take longer to dissolve. Such pellets could damage pool plaster and other surfaces in and around the pool.
- Do not use calcium chloride or potassium chloride as a source of salt. (Use sodium chloride only).
- Do not use Rock salt (insoluble impurities mixed with the rock salt can shorten the life of the IntelliChlor SCG).

How Much Salt to Use?

 **CAUTION - FOR ALL NEWLY SURFACED PLASTER POOLS:** Do not operate the IntelliChlor SCG with newly surfaced pool plaster. Salt is a corrosive element and severe salt damage can occur to your pool. Wait at least ONE (1) MONTH after construction to allow plaster to cure before adding salt and operating IntelliChlor SCG. Follow the pool surface manufacturer's guidelines for your specific pool.

FOR NEW VINYL LINER POOLS, contact the manufacturer for recommended guidelines before adding salt and operating the IntelliChlor SCG.

Use Table 2 (page 14) to determine how much salt will be needed. Most pools contain some salt, depending on the water source and chemicals used for sanitizing. Therefore, the pool owner must always test salt levels before adding salt. A hand held meter calibrated for NaCl (salt) can be used to determine the salt levels of the water. After the IntelliChlor SCG is powered on, the LED salt level lights will blink from bottom to top for two (2) minutes while it analyzes the pool water, then the LED indicators will show one (1) of four (4) salt level ranges. See “Salt Status LEDs” on page 7 for more information.

- 3600 ppm of salt is recommended for optimum water condition.
- Low salt concentration below 2600 ppm will cause the unit to turn off
- High salt concentration above 4500 ppm may cause excessive corrosion or deterioration to pool equipment and surrounding surfaces in and around the pool.

Note: Salt measurements will vary between measuring devices (salt test strips, electronic testers, and titration). The salt sensor reading is within +/- 500 ppm accuracy. For more troubleshooting information about high salt levels, see “Troubleshooting,” on page 28.

Calculating the Saturation Index

The saturation index is a formula that measures a solution ability to dissolve or deposit calcium carbonate and is used as an indicator of the corrosivity of the solution and temperature. A well balanced water will have a formula result ranging between -0.3 and +0.3 Outside this range, the pool water is considered out of balance, potentially damaging pool equipment or scaling the IntelliChlor SCG. The equation to calculate Si is:

$$SI = pH + CHF + AF + TF + TDSF$$

Satura- tion Index	pH as tested	Calcium Hardness Factor	Alkalinity Factor	Tempera- ture Factor	TDS Factor
--------------------------	-----------------	-------------------------------	----------------------	----------------------------	---------------

Cyanuric acid in the form of cyanurate ions contribute to alkalinity. Thus, a correction must be made to total alkalinity. We subtract 1/3 of the cyanuric acid level from the reading obtained in the total alkalinity test.

$$\text{Total Alkalinity} - 1/3 \text{ Cyanuric Acid} = \text{Corrected Alkalinity}$$

This correction can be considerable in established pools with high cyanuric acid levels; for example, at 100 ppm cyanuric acid, the correction amounts to 33 ppm (100 ÷ 3 = 33.3).

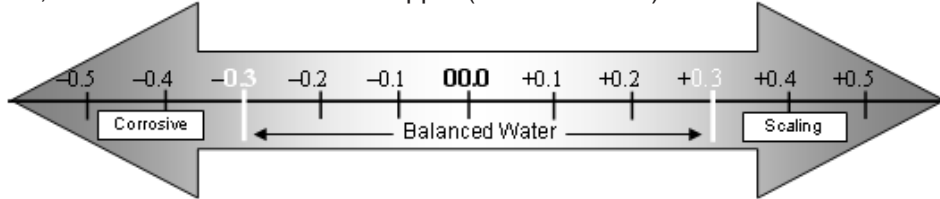

TDS Factor (Factors shown below are based on the actual measured value for the particular parameter)

TDS	Factor
<1000	12.10
1000	12.19
2000	12.29
3000	12.35
4000	12.41
5000	12.44

Langelier Saturation Index Factors

Temperature		TF	Calcium Hardness		Total Carbonate Alkalinity	
°F	°C		ppm (mg/L)	CHF	ppm (mg/L)	AF
32	0.0	0.0	25	1.0	25	1.4
37	2.8	0.1	50	1.3	50	1.7
46	7.8	0.2	75	1.5	75	1.9
53	11.7	0.3	100	1.6	100	2.0
60	15.6	0.4	125	1.7	125	2.1
66	18.9	0.5	150	1.8	150	2.2
76	24.4	0.6	200	1.9	200	2.3
84	28.9	0.7	250	2.0	250	2.4
94	34.4	0.8	300	2.1	300	2.5
105	40.6	0.9	400	2.2	400	2.6
			800	2.5	800	2.9

Note: Use the reading closest to your actual reading in choosing the factor.

Total alkalinity in this context refer to the total of carbonate and bicarbonate alkalinity. If cyanuric acid is used, a correction factor must be used (see cyanuric acid Table 1 on page 13).

How to Add Salt to the Pool

⚠ CAUTION - FOR ALL NEWLY SURFACED PLASTER POOLS: Do not operate the IntelliChlor SCG with newly surfaced pool plaster. Salt is a corrosive element and severe salt damage can occur to your pool. Wait at least ONE (1) MONTH after construction to allow plaster to cure before adding salt and operating IntelliChlor SCG. Follow the pool surface manufacturer's guidelines for your specific pool. **FOR NEW VINYL LINER POOLS,** contact the manufacturer for recommended guidelines before adding salt and operating the IntelliChlor SCG.

1. Check salt level in the water before adding any salt to pool.
2. Determine the amount of salt from the following chart.
3. Slowly pour the salt around the outer perimeter of the pool for quick and even distribution. *To avoid clogging the filter or damaging pool related equipment and surrounding surfaces, do not add salt through the skimmer or surge tank.*
4. Brush the pool bottom and allow water to circulate for 24 hours to dissolve salt completely.
5. After 24 hours, verify correct salt level reading by checking the LED indicators on the IntelliChlor SCG and by a separate reliable test method.
6. Power on the IntelliChlor® SCG and set the Sanitizer Output level to the proper setting to maintain the appropriate free chlorine levels in the pool water (i.e., within the 2.0 - 4.0 ppm, APSP recommended range).

Table 1. Approximate amount of stabilizer (cyanuric acid) to obtain 40 ppm in pool

Current Cyanuric Acid Level - ppm	10,000 g (38,000 L)	12,000 g (45,425 L)	14,000 g (53,000 L)	16,000 g (60,600 L)	18,000 g (68,137 L)	20,000 g (76,000 L)	22,000 g (83,300 L)	24,000 g (90,850 L)	26,000 g (98,421 L)	28,000 g (106,000 L)	30,000 g (134,000 L)
0	3.25 (1.47 kg)	3.90 (1.77 kg)	4.55 (2.6 kg)	5.20 (2.36 kg)	5.85 (2.65 kg)	6.50 (2.94 kg)	7.15 (3.24 kg)	7.80 (3.53 kg)	8.45 (3.83 kg)	9.10 (4.12 kg)	9.75 (4.42 kg)
10	2.43 (1.10 kg)	2.92 (1.32 kg)	3.40 (1.54 kg)	3.89 (1.76 kg)	4.37 (1.98 kg)	4.86 (2.20 kg)	5.35 (2.42 kg)	5.83 (2.64 kg)	6.32 (2.86 kg)	6.80 (3.08 kg)	7.29 (3.30 kg)
20	1.62 (0.73 kg)	1.94 (0.88 kg)	2.27 (1.03 kg)	2.59 (1.17 kg)	2.92 (1.32 kg)	3.24 (1.47 kg)	3.56 (1.61 kg)	3.89 (1.76 kg)	4.21 (1.91 kg)	4.54 (2.05 kg)	4.86 (2.20 kg)

NOTE: The cyanuric acid reading should be maintained at 30 - 50 ppm.

See Table 2 (page 14) for approximate pounds (lbs) / kilogram (kg) of salt needed to obtain 3,600 ppm in pool.

POOL SIZE IN GALLONS

	10,000	15,000	20,000	25,000	30,000	35,000	40,000	45,000	50,000	55,000	60,000
0											
lbs	300.43	450.65	600.87	751.08	901.30	1051.52	1201.73	1351.95	1502.17	1652.39	1802.60
Kg	136.27	204.41	272.55	340.68	408.82	476.96	545.09	613.23	681.37	749.51	817.64
250											
lbs	279.57	419.36	559.14	698.93	838.71	978.50	1118.28	1258.07	1397.85	1537.64	1677.42
Kg	126.81	190.22	253.62	317.03	380.43	443.84	507.24	570.65	634.05	697.46	760.86
500											
lbs	258.71	388.06	517.41	646.77	776.12	905.47	1034.83	1164.18	1293.53	1422.89	1552.24
Kg	117.35	176.02	234.69	293.37	352.04	410.71	469.39	528.06	586.73	645.41	704.08
750											
lbs	237.84	356.76	475.69	594.61	713.53	832.45	951.37	1070.29	1189.22	1308.14	1427.06
Kg	107.88	161.83	215.77	269.71	323.65	377.59	431.53	485.48	539.42	593.36	647.30
1,000											
lbs	216.98	325.47	433.96	542.45	650.94	759.43	867.92	976.41	1084.90	1193.39	1301.88
Kg	98.42	147.63	196.84	246.05	295.26	344.47	393.68	442.89	492.10	541.31	590.52
1,250											
lbs	196.12	294.17	392.23	490.29	588.35	686.41	784.47	882.52	980.58	1078.64	1176.70
Kg	88.96	133.43	177.91	222.39	266.87	311.35	355.83	400.30	444.78	489.26	533.74
1,500											
lbs	175.25	262.88	350.51	438.13	525.76	613.39	701.01	788.64	876.26	963.89	1051.52
Kg	79.49	119.24	158.99	198.73	238.48	278.23	317.97	357.72	397.46	437.21	476.96
1,750											
lbs	154.39	231.58	308.78	385.97	463.17	540.36	617.56	694.75	771.95	849.14	926.34
Kg	70.03	105.04	140.06	175.07	210.09	245.10	280.12	315.13	350.15	385.16	420.18
2,000											
lbs	133.53	200.29	267.05	333.82	400.58	467.34	534.10	600.87	667.63	734.39	801.16
Kg	60.57	90.85	121.13	151.42	181.70	211.98	242.26	272.55	302.83	333.11	363.40
2,250											
lbs	112.66	168.99	225.33	281.66	337.99	394.32	450.65	506.98	563.31	619.64	675.98
Kg	51.10	76.65	102.21	127.76	153.31	178.86	204.41	229.96	255.51	281.06	306.62
2,500											
lbs	91.80	137.70	183.60	229.50	275.40	321.30	367.20	413.10	459.00	504.90	550.80
Kg	41.64	62.46	83.28	104.10	124.92	145.74	166.56	187.38	208.20	229.02	249.84
2,750											
lbs	70.94	106.40	141.87	177.34	212.81	248.28	283.74	319.21	354.68	390.15	425.61
Kg	32.18	48.26	64.35	80.44	96.53	112.62	128.70	144.79	160.88	176.97	193.05
3,000											
lbs	50.07	75.11	100.14	125.18	150.22	175.25	200.29	225.33	250.36	275.40	300.43
Kg	22.71	34.07	45.42	56.78	68.14	79.49	90.85	102.21	113.56	124.92	136.27
3,250											
lbs	29.21	43.81	58.42	73.02	87.63	102.23	116.84	131.44	146.04	160.65	175.25
Kg	13.25	19.87	26.50	33.12	39.75	46.37	53.00	59.62	66.24	72.87	79.49
3,500											
lbs	8.35	12.52	16.69	20.86	25.04	29.21	33.38	37.55	41.73	45.90	50.07
Kg	3.79	5.68	7.57	9.46	11.36	13.25	15.14	17.03	18.93	20.82	22.71

C U R R E N T S A L I N I T Y L E V E L

Table 2. Approximate pounds (lbs) / kilogram (kg) of salt needed to obtain 3,600 ppm in pool

Section 3

Operating IntelliChlor® SCG

This section describes the start up procedure and operating instructions for IntelliChlor® SCG.

Before starting up and operating the IntelliChlor SCG, the pool in which the IntelliChlor SCG will be used must have been completed and filled with water for at least one (1) month (for plaster pools) and the pool water salt level must be stable and being maintained at 3600 ppm.

Initial Start up Period

For the first thirty (30) days of cell operation, the self-cleaning cycle, is factory set to two (2) hours. After thirty (30) days has elapsed, the IntelliChlor SCG will automatically set itself to a three (3) hour self-cleaning cycle. This feature will clean the IntelliChlor SCG blades more often during the initial installation, then go to a more standard self-cleaning cycle for longer cell life.

Operation

IMPORTANT! Use of an external Pool Pump Timer is Required

The IntelliChlor SCG is designed to supply a sufficient amount of chlorine to sanitize pool water on a daily basis. If the pool pump is continuously running and the IntelliChlor SCG is operated 24 hours a day at 100%, more chlorine would be generated than would be needed by most pools (2-4 ppm, per APSP recommendations). The IntelliChlor SCG has its own internal timer which cycles the electrolytic cell on and off depending on what percent the Sanitizer Output is set. For instance, at 100% the cell works all the time while the pool pump is running. When set at 80%, the cell is allowed to rest 20% of the time while the pool pump is running prolonging cell life. In order to fine tune IntelliChlor SCG to your pool size just increase or decrease the Sanitizer Output from 20% to 100% of the time. For more information, see “More and Less Output Buttons,” on page 8.

⚠ CAUTION - The IntelliChlor SCG is designed to only produce chlorine. The IntelliChlor SCG does not monitor or control chlorine levels in the pool or spa water. It is the pool owner's responsibility for monitoring and maintaining free chlorine levels at 2.0 to 4.0 parts per million (ppm) according to APSP recommendations. It is the pool owner's responsibility to check the free chlorine level while the pool pump is running on a regular basis, and adjust the Sanitizer Output on the IntelliChlor SCG accordingly.

⚠ CAUTION - Before attempting to operate IntelliChlor refer to “General Recommendations and General Cautions,” on page 17, and “Pool Water Preparation,” on page 6.

If you use a Pool Pump Timer

The Association of Pool and Spa Professionals (APSP) recommends that all water in a residential pool pass through the filtration system at least once every six (6) hours, four (4) turns every 24 hours (referred to as pool water turnover). However, many factors have an effect on actual pump and filter system run times. Pool size, source of water, direct sun light, indoor/outdoor, screened/unscreened, filtration system, cold or hot weather, swimmer load, rain, organic debris, algae, etc., are all factors which contribute to either more or less pool pump and filter system run times. Because of these differences, it is extremely difficult to set a standard initial run time (starting point) for the pool pump and chlorinating system.

If you use a Pool Pump Timer (Continued)

Try initially setting the pool pump timer to twelve (12) hours. It will take a few days to achieve the correct amount of pool pump operating time. When IntelliChlor® SCG is wired with a pool pump timer **results will vary greatly from one pool installation to the next, so this should be discussed with your pool professional.**

The key points are:

- Operate the pool pump at least the minimum time needed for good filtration and adequate chlorine production by the IntelliChlor SCG, according to your pool professional's recommendations.
- While pool pump timers can reduce energy consumption, the pool pump must be running for the IntelliChlor SCG to provide chlorine and must remain running long enough to maintain proper chlorine levels (i.e., 2.0 - 4.0 ppm of free available chlorine).

Note: Exception - For Cold Weather Operation: The unit turns off in water temperatures of 52° F, ±3° F (11° C, ±1.67° C) and below, and will not produce chlorine. This feature extends the life of the cell.

Start-up Procedure (Super Chlorination)

Super Chlorination is recommended before pool start-up. Start out with clean, properly chlorinated, pool water from the beginning. The IntelliChlor SCG will build up a sufficient level of chlorine for sanitation in several hours. However, if the pool water has a high demand from the start-up the IntelliChlor SCG will not be able to produce enough chlorine to reach break-point chlorination. So, it is best to super chlorinate using an outside source at the time of pool start-up. Then, wait until the chlorine level has returned to 2.0 to 4.0 ppm before switching on the IntelliChlor SCG.

Sanitizer Output Settings and Adjustments

- Switch on the pool pump switch or pool pump timer. The salt display will blink both LEDs (bottom to top) for two (2) minutes, indicating that it has not checked the salt level yet. After two (2) minutes, the salt will be checked and one (1) of the salt level LEDs will be displayed. If the salinity is below 2600 ppm, the salt display will light the red LOW SALT indicator, and the CELL light will go blank, indicating there is not enough salt in the pool for chlorine to be produced.
- Set the Sanitizer Output to 60% by pressing the **MORE** or **LESS** button (see page 8).
- After 24 hours, use a reliable test method to test the pool water for free available chlorine. The ideal range to maintain is 2.0-4.0 ppm. **If the free chlorine level of the pool water is too low, increase chlorine production by pressing the MORE button. If the free chlorine level of the pool water is too high, decrease chlorine production by pressing the LESS button.**
- Due to a varying free chlorine demand of pool water, it may take a few days to determine the number of daily pool operating hours and "Sanitizer Output" percentage setting (see page 8) for your pool. Continue adjusting as necessary, allowing 24 hours between adjustments until the free chlorine level of the pool water is stabilized at 2.0 - 4.0 ppm, per APSP recommendations.

Operating in Winter

The IntelliChlor SCG switches off and will not produce chlorine in water temperatures of 52° F, ±3° F (11° C, ±1.67° C) and below. This feature extends the life of the IntelliChlor SCG. See "Winterizing," on page 20.

General Recommendations

- After new pool construction has been completed, before installing the IntelliChlor® SCG, install the IntelliChlor “empty cell” (P/N 520588) to remove debris from the pipes for thirty (30) days and to allow sufficient time for the pool plaster (or other similar material) to properly cure and seal.
- Read and keep this Installation and User’s Guide in a safe place.
- Increase Sanitizer Output level as necessary after heavy rain (outdoor pools) and return to normal afterwards.
- Increase Sanitizer Output level when air and water temperature rise.
- Increase Sanitizer Output level when number of pool users increase.
- Use Cyanuric Acid ONLY as necessary to stabilize chlorine in the pool water in outdoor pools.
NOTE: DO NOT USE CYANURIC ACID IN INDOOR POOLS.
- Once a month take a pool water sample to a pool professional for a complete analysis.

General Cautions

- **Do not get fertilizer in your pool. Fertilizers contain nitrates, which cause a high chlorine demand.**
- **Never use dry acid to adjust pH in arid geographic areas with excessive evaporation and minimal dilution of pool water with fresh water. A buildup of byproducts can damage the IntelliChlor SCG.**
- **Do not add any pool water balancing chemicals (including salt) unless the IntelliChlor SCG is switched off.**
- **Do not let the Cyanuric Acid level drop below 30 ppm in outdoor pools.**
NOTE: DO NOT USE CYANURIC ACID IN INDOOR POOLS.

Section 4

User Maintenance

This section describes how to maintain the IntelliChlor® SCG.

Daily service

None is needed.

Weekly service

1. **pH Level Test:** Test the pH level of your pool water with a reliable test method. If necessary, adjust according to your pool professional's recommendations. APSP's recommended ideal range for pH is 7.4 to 7.6, although 7.2 to 7.8 is an acceptable range under APSP's guidelines.

Note: Never use dry acid (sodium bisulfate) to adjust pH in arid geographic areas with excessive evaporation and minimal dilution of pool water with fresh water. A buildup of byproducts can damage the IntelliChlor SCG.

2. **Total Alkalinity Test:** Test the pool water for total alkalinity with a reliable test method. Adjust according to your pool professional's recommendations. APSP's recommended ideal range for total alkalinity is 80 to 120 ppm.
3. **Chlorine Test:** Test the pool water for free chlorine level with a reliable test method. Maintain ideal range by adjusting the IntelliChlor SCG Sanitize Output settings. See "More and Less Output Buttons," on page 8.

- Desired Free Chlorine is 2.0-4.0 ppm, per APSP recommendations.

Note: Above 4.0 ppm of chlorine may cause excessive corrosion of metal components and possibly cause damage to associated pool equipment.

Note: It is recommended that free chlorine readings be taken from samples of pool water taken from two (2) places, one at the pool return line, the other well away from the pool return line. Compare the test results. A higher free chlorine level should be found at the pool return line. The higher free chlorine level at the pool return line indicates IntelliChlor SCG is producing chlorine.

Monthly Service

To ensure that the correct chemical balance is maintained in your pool, it is important to perform the following recommended salt and pool water tests every month using a reliable test method.

1. **Salt Level Test:** Check salt display lights on the unit and check that the green "GOOD" light is on and is not flashing.
 - If the red LOW LED salt light is on. Add salt to the pool water (see charts beginning on page 13).
 - If salt level does not rise after 24 hours, see "Troubleshooting," page 28.
2. **Pool Water Sample:** Take a sample of the pool water to your local pool store for testing.

Monthly Service (Continued)

3. **Cyanuric Acid:** Sample the pool water and test for cyanuric acid level using a reliable test method. When using the IntelliChlor SCG the recommended ideal cyanuric acid level is 30-50 ppm.
4. **Calcium Hardness:** Test pool water for calcium hardness level using a reliable test method. If necessary, adjust according to your pool professional's recommendations. APSP's recommended ideal range for calcium is 200 to 400 ppm for pools.
5. **Metals Test:** It is recommended that the pool water be sampled and tested periodically for the presence of metals such as copper, iron, and manganese. These metals can damage the IntelliChlor SCG and other related pool equipment and should not be present in the pool water. If those metals are present, contact your pool professional.
6. **TDS (Total Dissolved Solids):** Test pool water for TDS level using test kit or by having a water sample tested by a pool professional. If necessary, adjust according to your pool professional's recommendations. APSP standard of 3000 minimum to 5700 - 6000 maximum ppm (which includes the salt) is recommended for salt pools.

IntelliChlor SCG Usage Hours Meter

The IntelliChlor® SCG provides a built-in cell "usage hours" meter that reports how many hours IntelliChlor has been operating. The IntelliChlor SCG is designed to operate for approximately 10,000 hours before replacement is needed or roughly five (5) years of average use.

To access the system status mode:

1. Press and hold the **MORE** button for three (3) seconds until the lights scroll across the unit.
2. One (1) of the five (5) Sanitizer Output LED indicators (20%, 40%, 60%, 80% and 100%) will be lit, indicating the hours of usage. The Output LEDs are as follows:
 - 2000 hours (20% LED on)
 - 4000 hours (40% LED on)
 - 6000 hours (60% LED on)
 - 8000 hours (80% LED on)
 - 10,000 hours (100% LED on)

Cleaning the IntelliChlor SCG Cell Blades

Note: Before acid washing, remove the calcium buildup in cell: Use a garden hose on the jet setting and spray directly into both ends of the cell. Most of this calcium buildup has a slushy consistency and will be blown out of the cell. Once the majority of the calcium has been removed, continue with acid washing which will now be more effective since most of the calcium has been removed.

1. **Automatic Cleaning:** The IntelliChlor SCG has an automatic cell blade cleaning feature (cell reversing) that helps remove scale deposits from the IntelliChlor SCG blades. **Note:** Automatic cleaning does not interrupt chlorine production. "Scale" is a white crusty deposit that forms in excessively hard water or from pool water that is out of balance and in a scaling condition. If the IntelliChlor SCG blades show excessive scaling, you need to perform an acid wash cleaning. Proceed to "Acid Wash Cleaning," Step 2.
2. **Acid Wash Cleaning:** If the IntelliChlor SCG blades show a tendency to scale, it is recommended that every two (2) months the IntelliChlor SCG be removed and inspected for scale formation and/or debris on the IntelliChlor SCG blades. High hardness areas may require more frequent cleaning. Some filters allow debris to pass through to the IntelliChlor SCG, possibly lodging between the blades in the IntelliChlor SCG. A small amount of scale formation is normal. If by looking through the IntelliChlor SCG it is observed that there is excessive scale formation between the blades or debris is present, the IntelliChlor SCG must be cleaned as follows:
 - a. Use a high-pressure jet of water from a garden hose. If the blades cannot be reasonably cleaned in this manner, acid cleaning is necessary.

Cleaning the IntelliChlor® SCG Blades (Continued)

- b. **To acid clean the IntelliChlor SCG blades:** Disconnect the AC power from the Power Center. Disconnect the IntelliChlor SCG cell communication cable from the Power Center.
- c. Mix one (1) quart of muriatic acid with one (1) gallon of tap water in a plastic bucket.



Working with muriatic acid can be dangerous. When cleaning the IntelliChlor SCG always wear rubber gloves and eye protection. Always add acid to water, do not add water to acid. Always work in a well-ventilated area. Splashing or spilling acid can cause severe personal injury and/or property damage.

Note: The IntelliChlor SCG acid cleaning kit (P/N 520670) provides a cap for the IntelliChlor SCG to allow diluted acid solution to be poured into the IntelliChlor SCG to immerse the blades for cleaning.

- d. Screw the cap with washer and o-ring onto the threaded end of the IntelliChlor SCG cell (*the cap, o-ring and washer are provided with the cleaning kit*). Place the IntelliChlor SCG vertically in a five (5) gallon bucket. Pour the acid solution (as described in step c) into the IntelliChlor SCG until the cell blades and salinity probes are just covered. Allow the acid solution to bubble, and to clean the blades. *Note: The acid should only be contained inside the IntelliChlor SCG covering the blades. Try not to spill the acid on the outside of the IntelliChlor SCG. If acid does spill on the outside of the IntelliChlor SCG, wash it off with water.* A foaming action will begin, which is caused by scale (calcium carbonate) being dissolved from the blades. If rigorous foaming action does not begin, the blades do not need to be cleaned (**STOP THE CLEANING PROCESS - go on to step “e”**). **Otherwise, allow the blades to remain immersed in the solution until the foaming has stopped. However, do not leave acid in the IntelliChlor SCG for more than thirty (30) minutes. Excessive acid washing will damage the blades.**
- e. Remove the IntelliChlor SCG from the bucket and place in an empty five (5) gallon bucket. Rinse the inside and outside of the IntelliChlor SCG thoroughly with clean tap water and inspect. If deposits are still visible, repeat the acid cleaning process.
- f. Rinse the IntelliChlor SCG again with clean tap water and inspect. Once clean, replace the IntelliChlor SCG and resume normal operation.
- g. If the acid wash procedure is necessary, it is recommended that a sample of pool water be analyzed by a pool professional for excessive calcium hardness (i.e. ideal range is 200 to 400 ppm) and/or improper water balance.
- h. **Inspect the inside of the IntelliChlor SCG every two (2) months (or more frequent in hard water areas).** If no scale or debris deposits are observed inside the IntelliChlor SCG after four (4) months, it is not necessary to continue inspections every two (2) months. However, due to possible changes in pool water chemistry and filtering effectiveness, it is recommended that the cell be removed for inspection at least twice a year.
- i. Reconnect the IntelliChlor SCG communication cable plug in the Power Center, then reconnect AC power to the IntelliChlor SCG Power Center.

Winterizing

Very little chlorine production is needed in cold water so long as free chlorine levels are maintained at 2.0 - 4.0 ppm. The IntelliChlor SCG will not produce chlorine below 52° F ±3° F (11° C, ±1.67° C). This low-temperature cutoff extends the life of the cell. If preventative measures are not taken, freezing water may cause severe damage to the cell. Prevent freeze damage to the cell by running the pool pump continuously or winterize the pool by draining water from pump, filter, and all intake and return lines. Remove the cell, clean and store it.

Section 5

Installation

This section describes how to install the IntelliChlor® SCG into the pool plumbing system. Also, included are connection instructions for IntelliTouch, EasyTouch and SunTouch systems. Before installing, review the IntelliChlor kit contents and required tools.

Note: For Power Center installation instructions, see the “IntelliChlor Power Center Installation Guide” (P/N 520590).

Note: Salt is not provided. For details about the type of salt to use, see “What Type of Salt to Use,” on page 11.

Note: A TIME CLOCK must be used if the IntelliChlor SCG is used in “stand alone” mode without an automation control system.

Kit Contents

- One IntelliChlor SCG cell
- Two (2) cell unions with two (2) o-rings
- User’s Guide (this manual)

Required Tools

- Tape measure
- Phillips and flathead screwdriver
- Pliers
- Hacksaw
- An NSF® approved all purpose PVC/CPVC/ABS cleaner primer
- An NSF® approved all purpose PVC/CPVC/ABS cement

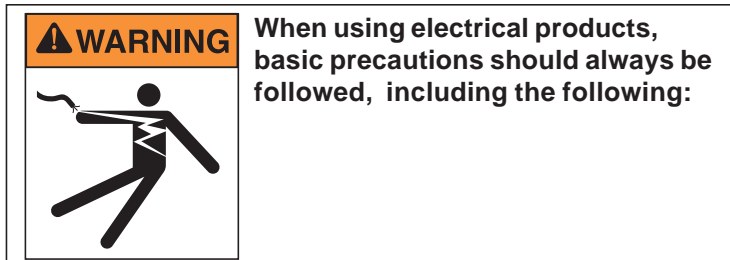

- **DANGER: RISK OF ELECTRIC SHOCK, WHICH CAN RESULT IN SERIOUS INJURY OR DEATH.** Before attempting installation of service, ensure that all power to the circuit supplying power to the system is disconnected/turned off at the circuit breaker. It is recommended, but not mandatory that the IntelliChlor Power Center be connected to a circuit protected by a ground fault circuit-interrupter (GFCI).
- Grounding (earth bonding) is required. The unit should be installed by a qualified service person and grounded.
- Install to allow access to cell buttons and power center.
- **Read Safety Precautions and Important Instructions (page ii and iii). Before attempting any electrical wiring, be sure to read and follow Safety Instructions. Wiring should only be performed by a qualified professional.**
- Install the IntelliChlor unit a minimum of three (3) feet away from the heater outlet.
- Pipe couplings: Schedule 80, maximum pressure 75 psi at 70° F (21° C).
- **Note:** Operate unit with minimum flow of 25 gpm. For high flow applications, use a bypass loop (see page 4) for best flow sensing.
- **Note:** Provide at least 12"-18" of straight pipe in front of the cell inlet.

IntelliChlor® SCG “Pass-Through” Cell

After new pool construction has been completed, in order to prevent debris from entering the IntelliChlor SCG, it is recommended that the IntelliChlor SCG “pass-through” cell (P/N 520588) be installed before installing the IntelliChlor SCG. After the pool system has flushed the debris from the pipes, remove the “dummy cell” and install the IntelliChlor SCG.

Selecting Model Size (see chart on page 1)

Installing the IntelliChlor SCG Cell Assembly

Install the IntelliChlor cell assembly no closer than three (3) feet away from the heater outlet, if used. For more information see plumbing diagrams on page 4 and 5.

Note: For best flow sensing, provide at least 12"-18" of straight pipe in front of the cell inlet.

Note: After new pool construction has been completed, in order to prevent debris from entering the IntelliChlor cell assembly, it is recommended that the IntelliChlor SCG pass-through cell (P/N 520588) be installed before installing the IntelliChlor SCG cell. After the pool system has flushed the debris from the pipes, remove the pass-through cell and install the IntelliChlor cell.

Note: Pipe couplings: Schedule 80, maximum pressure 75 psi at 70° F (21° C)

To install the IntelliChlor® SCG Cell:

1. Using PVC glue, mount the PVC couplings to the plumbing pipe. Allow the glue to dry.
2. Mount the cell vertically. Allow access to the cell operator control panel. Install the cell onto the couplings. Ensure the O-rings are seated properly.
3. Switch on the pump and visually inspect for leaks around the couplings.

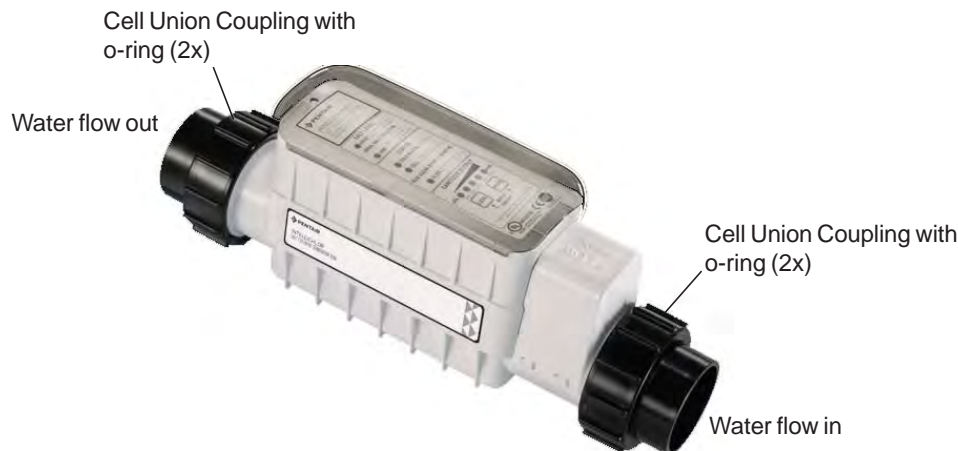

Connecting the IntelliChlor IC20, IC40 IC60 SCG Cell Power Cable to the Power Center

After the cell installation is completed, connect IntelliChlor SCG cell's power cable to the Power Center:

⚠ WARNING - Switch OFF main system power to the Power Center before making any connections.

1. Be sure that AC power is switched OFF before connecting the power cord to the Power Center.
2. Align the four (4) pins of the cell power cord connector with the socket on the bottom of the Power Center and insert the connector. Turn the round socket nut until it locks the connector in place.

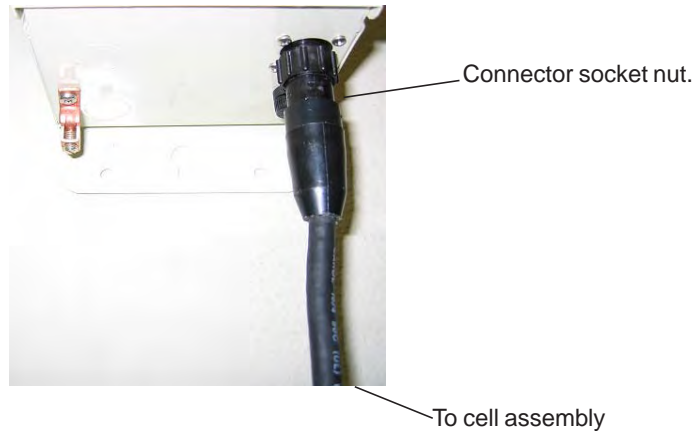

⚠ CAUTION - The CIC60P or CIC60S can only be plugged into a PC100 or CPC100 power center. Do not plug into IntelliTouch, EasyTouch or SunTouch systems.

Section 6

Troubleshooting

Use the following troubleshooting information to resolve possible problems with the IntelliChlor® Salt Chlorine Generator.

⚠ WARNING - Switch OFF main system power to the IntelliChlor SCG cell before before servicing.

Note: Switch power off to unit before to attempting service or repair. Always remove AC power to Power Center when plugging or unplugging the IntelliChlor SCG cell into the Power Center.

Table 1: Troubleshooting

Problem	Possible Cause	Corrective Action
Low or no chlorine.	Low stabilizer (cyanuric acid) level in pool water (outdoor pools only).	Add cyanuric acid in outdoor pools only to maintain 30 - 50 PPM per pool professional's recommendations. See Stabilizer Chart, Table 1, page 13.
	Insufficient operating hours of the IntelliChlor SCG.	Increase the SCG operating time per day. See page 15 for pump run time information.
	SANITIZER OUTPUT percentage set too low or off at 0%.	Increase SANITIZER OUTPUT by pressing the MORE button. See page 8.
	Recent increases in weather temperature without increasing the SCG Sanitizer Output.	Increase SANITIZER OUTPUT by pressing the MORE button. See page 8.
	Temporary loss of chlorine due to heavy organic load, rain, leaves, fertilizer or heavy bather load, recent party, or pets using pool.	Set "Boost" mode and allow to run for 24 hours. Recheck, If still too low, super-chlorinate by using an outside source. (Take pool water sample to pool professional).
	Low (less than 2600 ppm) salt level in pool water, shuts off chlorine production.	Observe Salt Display lights. See "Salt Level Status LEDs," page 7.
	High nitrate and phosphate level.	Contact Pool Professional.
	Metals present in pool water.	Contact Pool Professional.
	New pool water, or not shocked properly upon startup.	Super Chlorinate Pool. See "Start-up Procedure (Super Chlorination)", page 16.
	Clogged or dirty cell.	Remove cell for inspection. Clean if necessary. (see page 19).

Table 1: Troubleshooting (Continued)

Problem	Possible Cause	Corrective Action
Red LOW salt LED is on.	Pool water needs salt. No chlorine is being produced.	Add salt as described on pages 13, 14.
Red LOW SALT light on and green CELL light flashing	Salt level in pool water is low and may need inspecting.	Check salt level, add if necessary to GOOD level. Allow 24 hours for salt to mix in water. If CELL light is still flashing after 24 hours, remove and inspect cell and clean if necessary.
Red CHECK SALT light is on	Not enough salt in pool. Heavy Rainfall. Leak in pool.	Add salt to pool to achieve 3600 ppm. See page 12, 13.
Green GOOD salt light is flashing	Too much salt in pool. May cause damage to pool related equipment and surrounding surfaces.	Dilute pool water by draining some water, then filling with fresh water
COLD WATER light is red.	Water is below 52°F.	The water temperature must be above 52°F to produce chlorine.
CELL light does not come on.	Chlorine Production set to 00%.	Adjust CHLORINE PRODUCTION to desired percentage.
	Insufficient water flow. Cell is plugged with debris, pump has lost prime.	Remove obstruction and/or clean cell. See page 10. Prime pump if necessary.
	Salt level below 2600 ppm.	Add salt as described on pages 12, 13.
CELL light is flashing green.	Check salt level	Add salt if necessary to maintain 3600 ppm minimum.
	Cell has calcium build-up and requires cleaning.	Refer to Maintenance Procedure for acid wash/cleaning. See "User Maintenance," on page 18.
	Check water chemistry and balance. NOTE metal content should be 0 ppm.	Remove metals from water using chemical solution.
Flow light is red.	Pump fails to provide sufficient water flow.	Check for correct operation of the pump, i.e., loss of pump prime or clogged strainer baskets.
	Closed valves.	Check and correct all valve alignments.
	Dirty filter.	Follow filter cleaning procedures.
	Obstruction in the SCG cell.	Remove cell for inspection. Follow cleaning procedures. See "Electrolytic Cell Cleaning," on page 10.
IntelliChlor unit does not have power.	Fuse in Power Center is open.	Replace AC fuse, located at bottom of Power Center.
	No AC power to Power Center.	Verify time clock is providing 110 VAC or 220 VAC to Power Center when active.
	Transformer leads not wired correctly in Power Center.	Verify transformer leads wired to AC source by referring to wiring diagram decal on inside of Power Center cover.

System Specifications - 110 VAC and 230 VAC Wiring

Circuit Protection: Two-pole 20 AMP device at the electrical panel.

IntelliChlor SCG Model CIC60P and CIC60P

Input: 95-130 VAC, 50/60 Hz, 220 Watts (2 AMP) or 220-240 VAC, 50/60 Hz, 220 Watts (1 AMP).

Output: 22-39 VDC @ 7.5 AMPS maximum from the Power Center.

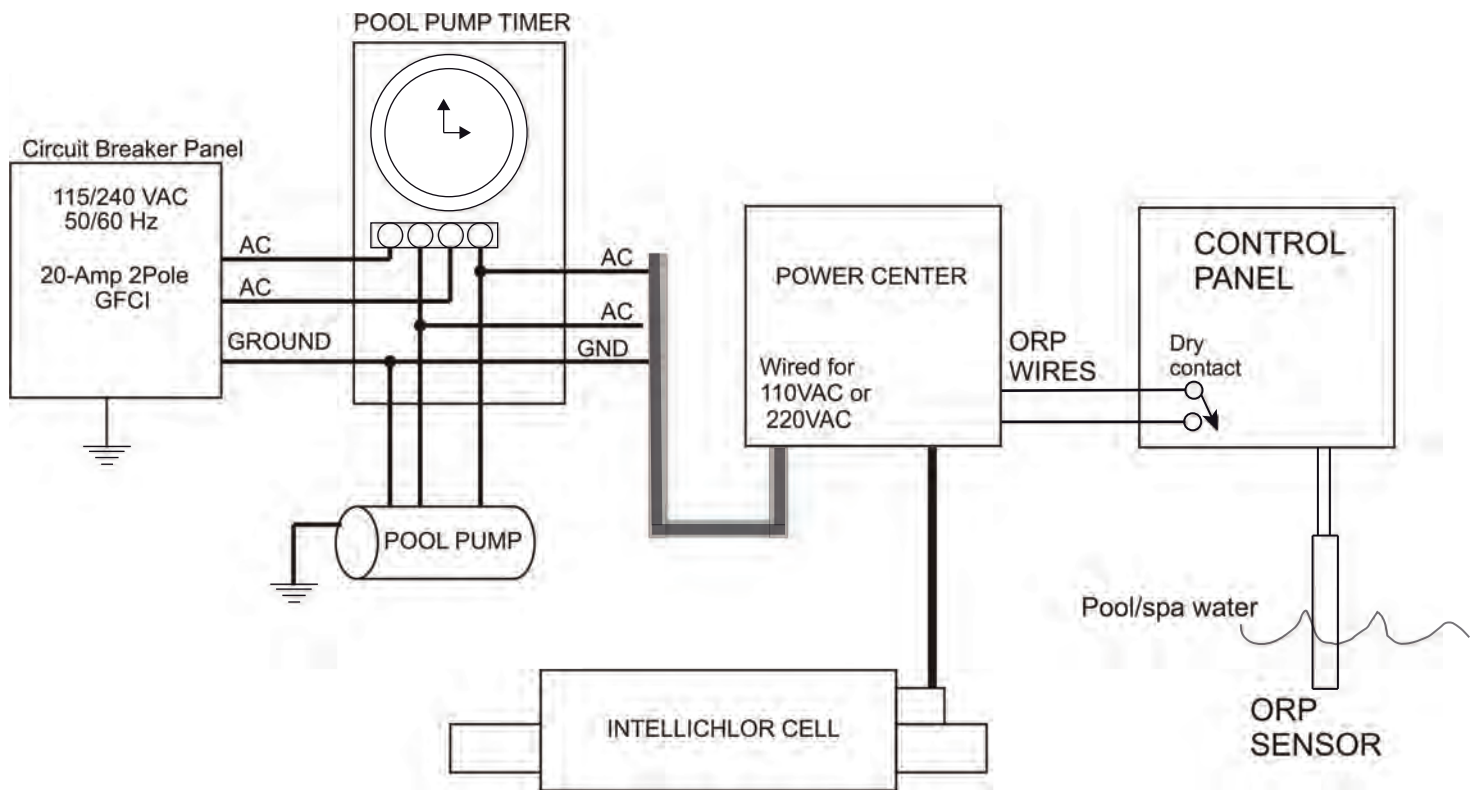

Basic System Wiring with ORP System

 **WARNING**

Salt is an inherently corrosive material. While the levels of salt required for proper operation of the IntelliChlor Salt Chlorine Generator (SCG) are relatively low when compared to sea water and other salt solutions, placing any amount of salt in your pool increases the likelihood of corrosion or other deterioration of pool equipment and any surfaces used in and around your pool. Metal parts (including metal pools) and certain natural and man-made surfaces are particularly susceptible to corrosion and deterioration when used in and around salt water pools. Pentair Water Pool and Spa, Inc. ("Pentair") does not represent or otherwise guarantee that the proper use of the (SCG) will prevent corrosion or other deterioration of pool equipment and any surfaces used in and around your pool. Consult your experienced pool professional, who should be able to advise you on the proper material selection, installation techniques for those materials, and the proper use, care and maintenance of those materials for your specific pool type and location in order to minimize the corrosion and deterioration that is inherent in and around salt water pools.



1620 HAWKINS AVE., SANFORD, NC 27330 • (919) 566-8000
10951 WEST LOS ANGELES AVE., MOORPARK, CA 93021 • (805) 553-5000

© 2023 Pentair. All rights reserved. WWW.PENTAIR.COM



P/N 521011 REV. E 8/7/23