

English

122  
PO

## IMPORTANT SAFETY RULES

Read, understand, and follow all  
instructions carefully before installing  
and using this product.

# Deluxe Wall Mount Surface Skimmer



Don't forget to try these other fine Intex products: pools, pool accessories, inflatable pools and in-home toys, airbeds and boats available at fine retailers or visit our website.

**INTEX**<sup>®</sup>

## IMPORTANT! DO NOT RETURN PRODUCT TO STORE

To purchase parts and accessories or to obtain non-technical assistance,  
Visit [www.intexcorp.com](http://www.intexcorp.com)

For technical assistance and missing parts call us toll-free (for U.S. and Canadian Residents):

**1-800-234-6839**

Monday through Friday, 8:30am to 5:00pm Pacific Time

122PO-R0-1107

OWNER'S MANUAL

**TABLE OF CONTENTS**

<b>Warnings.....</b>	<b>3</b>
<b>Parts Reference.....</b>	<b>4</b>
<b>Hook Assembly for Easy-Set® Pools with Inflatable Top Rings.....</b>	<b>5</b>
<b>Hook Assembly for Metal Frame Pools.....</b>	<b>6</b>
<b>Setup Instructions.....</b>	<b>7-9</b>
<b>Long Term Storage.....</b>	<b>10</b>
<b>General Aquatic Safety.....</b>	<b>10</b>
<b>Intex Service Center Locations.....</b>	<b>11</b>

# IMPORTANT SAFETY RULES

Read, Understand and Follow All Instructions Carefully Before Installing and Using this Product.

## WARNING

- Do not permit children to use this product. Adult use only.
- Do not operate the filter pump while the pool is occupied or in use.
- Strong suction. Do not remove or obstruct the floating cover opening while the filter pump is operating!
- Keep hands and hair away from the skimmer and floating cover opening when the filter pump is operating!
- Turn off or unplug the filter pump before adjusting, cleaning, servicing or removing the skimmer, basket or floating cover.
- Remove all maintenance items when the pool is in use.

**FAILURE TO FOLLOW THESE WARNINGS MAY RESULT IN PROPERTY DAMAGE, ELECTRIC SHOCK, SERIOUS INJURY, DROWNING OR DEATH.**

These product warnings, instructions and safety rules provided with the product represent some common risks of water recreation devices and do not cover all instances of risk and danger. Please use common sense and good judgement when enjoying any water activity.

**Filter Pump Flow Rate Requirement:**

800 - 4000 gallons/hour (3028 - 15140 liters/hour)

## PARTS REFERENCE

Before assembling your product, please take a few minutes to check the contents and become familiar with all the parts.

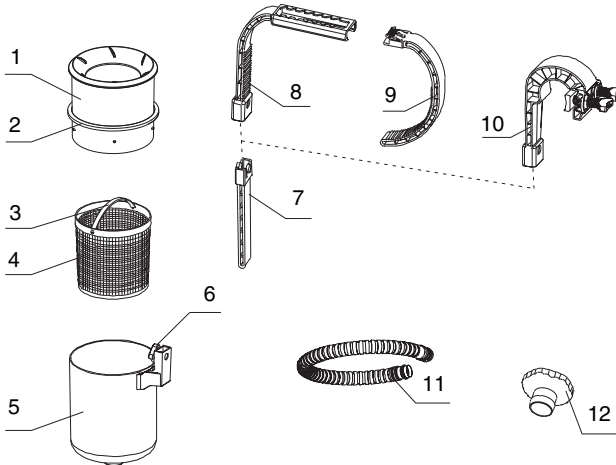

**NOTE:** Drawings for illustration purpose only. Actual product may vary. Not to scale.

EASY-SET® POOL	REF. NO.		DESCRIPTION	QTY.	SPARE PARTS NO.
	FRAME POOL	COMMON			
		1	FLOATING COVER	1	11075
		2	COVER RIM	1	11076
		3	BASKET HANDLE	1	11077
		4	BASKET (BASKET HANDLE INCLUDED)	1	11078
		5	SKIMMER	1	11079
		6	SCREW	1	10526
		7	DEPTH ADJUSTER	1	10522
8			HOOK (OPTIONAL)	1	10521
9			ARM (OPTIONAL)	1	10520
	10		FRAME HOOK (OPTIONAL)	1	11154
		11	SKIMMER HOSE	1	10531
		12	HOSE ADAPTOR B	1	11238

# SAVE THESE INSTRUCTIONS

## HOOK ASSEMBLY FOR EASY SET® POOLS WITH INFLATABLE TOP RINGS

1

**NOTE:** If you are using a METAL FRAME POOL, go to page 7.

Connect the skimmer hose (11) to the skimmer (5) bottom connector.

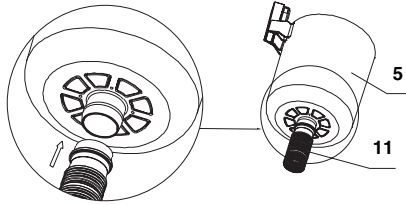

2

Assemble the hook as shown. Adjust the opening of the hook (8) by pressing and sliding the arm (9) at the same time.

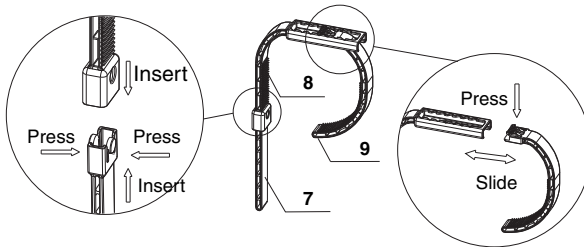

3

Loosen the skimmer screw (6), attach the assembled hook and hand tighten the screw. **NOTE:** Do not over tighten or use tools such as pliers.

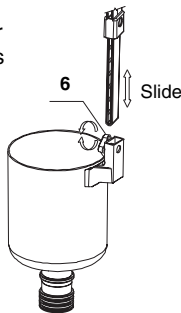

4

Place the whole assembled hook unit over the top of an

EASY-SET® pool top ring near the water inlet connector (lower hose connection). Adjust the hook to be snug around the inflated ring (see step #2). Ensure the hook is securely tightened over the pool.

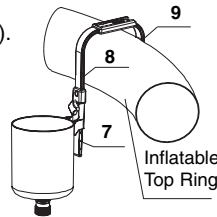

## HOOK ASSEMBLY FOR METAL FRAME POOLS

1

Connect the skimmer hose (11) to the skimmer (5) bottom connector.

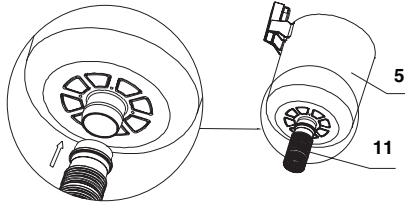

2

Assemble the hook as shown.

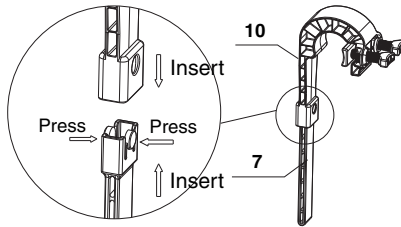

3

Loosen the skimmer screw (6), attach the assembled hook and hand tighten the screw.  
NOTE: Do not over tighten or use tools such as pliers.

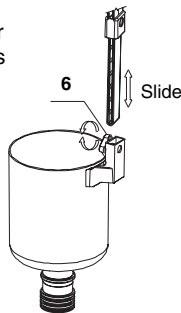

4

Place the whole assembled hook unit over the top of a frame pool horizontal beam near the water inlet connector (lower hose connection). Adjust the hook by adjusting the two dove-tail screws, to be tight on the top beam. Ensure the hook is securely tightened over the pool top beam.

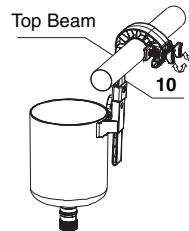

## SETUP INSTRUCTIONS

# 1

**For pool size 16' (488 cm) and below:**  
Unscrew the strainer grid from the threaded strainer connector (lower) from inside of the pool.

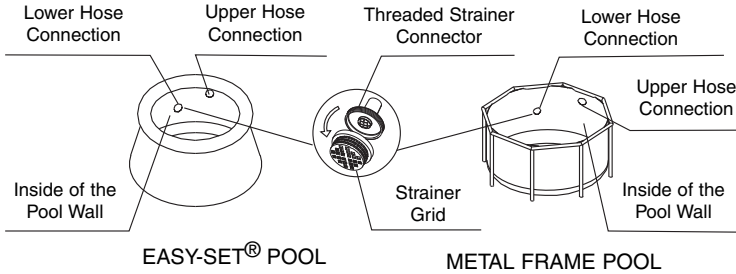

# 2

Depending on the size of pool purchased.

**For 16' (488 cm) and below pools with Strainer**

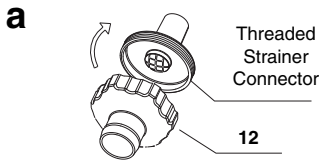

Screw the hose adaptor B (12) to the threaded strainer connector, from inside of the pool.

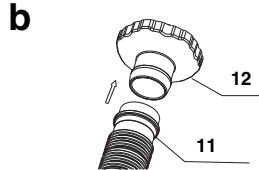

Connect the other end of the skimmer hose (11) to the hose adaptor B (12).

**For 18' (549 cm) and above pools with Large Strainer**

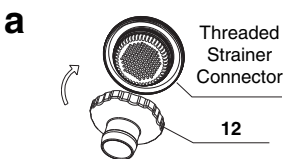

Screw the hose adaptor B (12) to the threaded strainer connector, from inside of the pool.

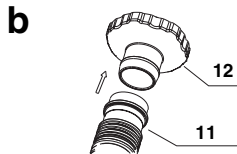

Connect the other end of the skimmer hose (11) to the hose adaptor B (12).

## SETUP INSTRUCTIONS (continued)

3

Place the basket (4), cover rim (2) and the floating cover (1) into the skimmer (5). **NOTE:** The cover rim must be installed in place in order to hold the floating cover in position.

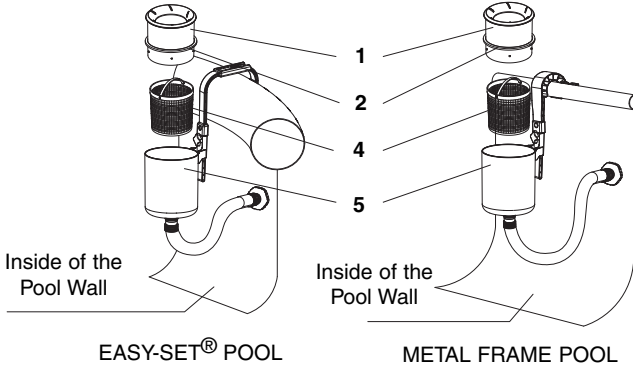

4

The floating cover (1) should be floating off the skimmer (5) by 1" to 5" (2.5cm to 12.7cm). Loosen the skimmer screw, slide the skimmer up and down on the assembled hook to adjust the height. Hand tight the screw when done.

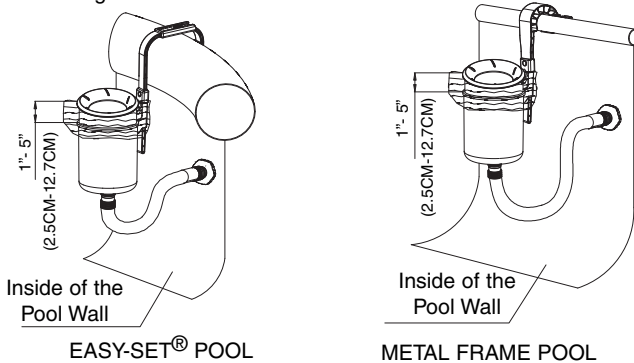

**IMPORTANT:** The skimmer must stay vertical at all times, so that the top of the floating cover can parallel to the water surface for skimming.

## SETUP INSTRUCTIONS (continued)

5

### WARNING

- Do not operate the filter pump while the pool is occupied or in use.
  - Strong suction. Do not remove or obstruct the floating cover opening while the filter pump is operating!
  - Keep hands and hair away from the skimmer and floating cover opening when the filter pump is operating!
  - Turn off or unplug the filter pump before adjusting, cleaning, servicing or removing the skimmer, basket or floating cover.
- 
- Set up the filter pump following the filter pump owner's manual. Turn on or connect the filter pump to an electrical outlet.

### IMPORTANT

If no water is flowing into the pump, make sure that the surface skimmer is perpendicular to the water surface and below the water surface. Open the air release valve located on the filter housing top cover. When water starts to flow out, close the air release valve back.

**Never run the pump dry as the motor may overheat and damage the pump!**

- Remove the skimmer and the hook assembly from the pool before placing a pool cover over the pool.
- Store the product and accessories in a dry and safe place indoors.

SETUP INSTRUCTIONS

## LONG TERM STORAGE

1. Make sure the filter pump is turned off and disconnect the power cord from the electrical outlet.
2. Using the Set-Up instructions in reverse, disassemble the floating surface skimmer.
3. Clean and air dry all the accessories and parts thoroughly.
4. The original packaging can be used for storage. Store in a dry, cool storage location.

## GENERAL AQUATIC SAFETY

**Water recreation is both fun and therapeutic. However, it involves inherent risks of injury and death. To reduce your risk of injury, read and follow all product, package and package insert warnings and instructions. Remember, however, that product warnings, instructions and safety guidelines cover some common risks of water recreation, but do not cover all risks and dangers.**

**For additional safeguards, also familiarize yourself with the following general guidelines as well as guidelines provided by nationally recognized Safety Organizations:**

- Demand constant supervision. A competent adult should be appointed as a "lifeguard" or water watcher, especially when children are in and around the pool.
- Learn to swim.
- Take the time to learn CPR and first aid.
- Instruct anyone who is supervising pool users about potential pool hazards and about the use of protective devices such as locked doors, barriers, etc.
- Instruct all pool users, including children what to do in case of an emergency.
- Always use common sense and good judgement when enjoying any water activity.
- Supervise, supervise, supervise.

**For additional information on safety, please visit**

- **The Association of Pool and Spa Professionals: The Sensible Way to Enjoy Your Aboveground/Onground Swimming Pool** [www.nspi.org](http://www.nspi.org)
- **American Academy of Pediatrics: Pool Safety for Children** [www.aap.org](http://www.aap.org)
- **Red Cross** [www.redcross.org](http://www.redcross.org)
- **Safe Kids** [www.safekids.org](http://www.safekids.org)
- **Home Safety Council: Safety Guide** [www.homesafetycouncil.org](http://www.homesafetycouncil.org)
- **Toy Industry Association: Toy Safety** [www.toy-tia.org](http://www.toy-tia.org)

### SAFETY IN YOUR POOL

**Safe swimming depends on constant attention to the rules. The "NO DIVING" sign within this manual can be posted near your pool to help keep everyone alert to the danger. You may also wish to copy and laminate the sign for protection from the elements.**

**COUNTRIES/REGIONS**

**SERVICE CENTER LOCATIONS**

- UNITED STATES
- CANADA

**INTEX RECREATION CORP.**  
 14779 Bar Harbor Road  
 Fontana, CA 92336  
 Tel: 1-800-234-6839  
 Fax: 310-549-2900  
 Website: [www.intexcorp.com](http://www.intexcorp.com) (U.S./Canada only)  
 Consumer Service Hours: 8:30 am to 5:00 pm  
 Pacific Time, Mon. thru Fri. only.

- MEXICO

**KAY INTERNACIONAL, S.A. DE C.V.**  
 SAN JERONIMO # 550- INT.501 Y 502. COL.  
 JARDINES DEL PEDREGAL. C.P. 01900  
 MÉXICO D.F.  
 Tel: 01-800-347-4020 (Collect Call)  
 Tel: 55-9172-8035  
 Fax: 55-9172-8047  
 E-mail: [servicenter@kayinternacional.com](mailto:servicenter@kayinternacional.com)  
 Website: [www.intexmexico.com.mx](http://www.intexmexico.com.mx)

- PANAMA
- PARAGUAY
- ECUADOR
- HONDURAS
- EL SALVADOR
- NICARAGUA

**SUPRO MUNDIAL S.A./  
 PRODUCTOS SUPERIORES S.A.**  
 Boulevard Andrews, Albrook,  
 Panama, Rep. of Panama  
 Tel: 507-300-3800  
 Fax: 507-300-3813  
 E-mail: [suproadmin@supropanama.com](mailto:suproadmin@supropanama.com)

- COSTA RICA
- DOMINICAN REPUBLIC
- GUATEMALA
- COLOMBIA
- VENEZUELA

**CENTURY USA, LLC**  
 4731 W. Atlantic Ave., Suite B-3  
 Delray Beach, FL 33445, USA  
 Tel: 561-495-0648  
 Fax: 561-495-4782  
 E-mail: [sales@centuryusa.com](mailto:sales@centuryusa.com)

- MIDDLE EAST REGION  
 REGION

**FIRST GROUP INTERNATIONAL**  
 AL MOOSA GROUP BUILDING, 1ST FLOOR,  
 OFFICE 102 & 103, UMM HURAIR ROAD,  
 KARAMA, DUBAI, UAE  
 TEL: 00971-4-800INTEX(46839) / +971-4-3373322  
 FAX: 00971-4-3375115  
 E-mail: [intex@firstgroupinternational.com](mailto:intex@firstgroupinternational.com).  
 Website: [www.firstgroupinternational.com](http://www.firstgroupinternational.com)

- ASIA

**INTEX DEVELOPMENT CO. LTD.**  
 9th Floor,  
 Dah Sing Financial Centre  
 108 Gloucester Road,  
 Wanchai, Hong Kong  
 Tel: 852-28270000  
 Fax: 852-23118200  
 E-mail: [xmservicesupport@intexcorp.com.cn](mailto:xmservicesupport@intexcorp.com.cn)  
 Website: [www.intexdevelopment.com](http://www.intexdevelopment.com)

For answers to most frequently asked questions, please visit  
[www.intexcorp.com](http://www.intexcorp.com). Non U.S. Residents, please visit  
[www.intexdevelopment.com](http://www.intexdevelopment.com).

English

®  
INTEX

***For Residents of the U.S. & Canada:***

**INTEX RECREATION CORP.**

**Attn: Consumer Service**

**14779 Bar Harbor Road**

**Fontana, CA 92336**

**Phone: 1-800-234-6839**

**Fax: (310) 549-2900**

**Consumer Service Hours:**

**8:30 am to 5:00 pm Pacific time**

**Monday thru Friday only**

**Website: [www.intexcorp.com](http://www.intexcorp.com)**

***For Residents outside of the U.S. and Canada:***

***Please refer to the Service Center Locations***

©2010 Intex Marketing Ltd. - Intex Development Co.  
Ltd. - Intex Trading Ltd. - Intex Recreation Corp.  
All rights reserved/Tous droits réservés/Todos los  
derechos reservados/Alle Rechte vorbehalten.  
Printed in China/Imprimé en Chine/Impreso en  
China/Gedruckt in China.

®™ Trademarks used in some countries of the world  
under license from/®™ Marques utilisées dans certains  
pays sous licence de/Marcas registradas utilizadas en  
algunos países del mundo bajo licencia  
de/Warenzeichen verwendet in einigen Ländern der  
Welt in Lizenz von/Intex Marketing Ltd. to/à/a/an Intex  
Trading Ltd., Intex Development Co. Ltd., G.P.O Box  
28829, Hong Kong & Intex Recreation Corp., P.O.  
Box 1440, Long Beach, CA 90801 • Distributed in the  
European Union by/Distribué dans l'Union Européenne  
par/Distribuido en la unión Europea por/Vertrieb in der  
Europäischen Union durch/Intex Trading B.V., P.O. Box  
nr. 1075 – 4700 BB Roosendaal – The Netherlands

 INTEX®